



**BEITER**  
BUILD BETTER

PROFESSIONAL PRECISION TOOLS  
POWER TOOLS & HAND TOOLS

**PRODUCT CATALOG**

**2024**



Designed in USA

**BEITER TECHNOLOGIES USA LLC    BEITER INTERNATIONAL LIMITED**

[www.beitertools.com](http://www.beitertools.com)

V1 Q4



BEITER Precision Tools is originated from an inspiration and vision to modernize the home renovation experience by building better homes and better lives.

Beiter is a profound international brand of Woodwell Group, a 2-generation business over 40 years of experience in manufacturing and distributing professional construction tools. Beiter is based in California has launched off at numerous trade shows. Currently, Beiter serves the Americas, Europe, Asia, Australia and Middle East region.

The Beiter brand is originated from the German word "bauarbeiter", which means professional home builder. It aims to focus on users that from home improvement builders to professional contractors, to large scale construction projects.



**We provide both Beiter Standard package & OEM design package service.**



A proud family member of Wah Tat Woodwell Group. *Serving families from family since 1982.*

For two generations, we live by the values of:

- SUSTAINABILITY**
- IDEAS
- TEAM WORK
- PRESERVATION
- LONGTERM VISION
- FAMILY
- PARTNERSHIP**
- SYNERGY
- GLOBAL THINKING**
- HAPPINESS
- QUALITY LIVING
- CHILDREN**
- EQUITY & INCLUSION
- INNOVATION
- FAIR OPPORTUNITY
- BUILD BETTER**



**Environmental  
Social  
Governance**



# Meet the WHALES

Extremely dust-proof, water-proof.



**WHALE-8X-G**

**WHALE-8X-R**

**NEW**  
LASER LEVELS



## WHALE-8X-R

Heavy Duty-Grade 8 lines Laser Level - Red



## WHALE-8X-G

Heavy Duty-Grade 8 lines Laser Level - Green

Technical Data	
Working Range	30m (70m with Receiver)
Beam Display/Planes	1x Horizontal (360°), 4 x Vertical
Accuracy	±2mm/10m
Self-leveling Range	±3.5°
Self-leveling Time	≤ 3 sec
Laser Class/ Wavelength	Class II 515nm-530nm (Green)
Waterproof/ Dustproof	IP67
Power Supply	5200mAh Li-ion Battery
Power Capacity Signal	Yes
Operating Hours on Full Charge	6.5/hr*
Operating Temperature	-10° C ~ 45° C
Incline Mode	Transport Lock & Individually Shiftable Function
Out-of-level-indication	Optical Signal and Audio Alert
Tripod Thread	1/4" & 5/8"
Weight	735g
Size	104 x 89 x124mm

\* Battery life deteriorates in time.

## HEAVY-DIY



### Standard Premium Package:

- Laser x1
- Li-ion Battery x1
- Type-C USB
- Charger
- Fine-tuning Rotating Base
- Ceiling Wall Mount
- Wall iron
- Elevating Flooring Base
- Laser Target
- Remote Control
- Hard Carrying Case

### Breakthrough Dustproof + Waterproof Design. IP67



High Capacity Battery



Remote Control



**NEW**  
LASER LEVELS



## WHALE-16X

Heavy Duty-Grade Full function 4D Laser Level - Green

### 3D Models Options:



**WHALE-12X**  
Horizontal plane on top  
Size: 131 x 109 x137mm



**WHALE-12XF**  
Horizontal plane on bottom  
Size: 131 x 109 x151mm

Technical Data	
Working Range	30m (70m with Receiver)
Accuracy	±2mm/10m
Self-leveling Range	±3°
Self-leveling Time	≤ 3 sec
Laser Class/ Wavelength	Class II 515nm-530nm
Waterproof/ Dustproof	IP54
Power Supply	5200mAh Li-ion Battery
Power Capacity Signal	Yes
Operating Temperature	-10° C ~ 45° C
Incline Mode	Transport Lock & Individually Shiftable Function
Out-of-level-indication	Optical Signal and Audio Alert
Tripod Thread	1/4" & 5/8"
Weight	853-951g
Size	131 x 109 x 160mm



### Standard Premium Package:

- Laser x1
- Li-ion Battery x1
- Type-C USB
- Charger
- XYZ-axis Fine-tuning Base
- Ceiling Wall Mount
- Wall iron
- Elevating Flooring Base
- Laser Target
- Remote Control
- Hard Carrying Case



**NEW**  
LASER LEVELS

## Motion Sensor!



- **Advanced Motion Sensing Technology:**

Automatically detects and adjusts to maintain the perfect level.

- **Ultra-Precise Alignment:**

Achieve flawless, straight lines every time.

- **Hands-Free Operation:**

Set it, move around, and watch the level adjust itself!

- **Easy Rotation Mechanism:**

User-friendly design ensures a smooth and hassle-free operation.

**NEW**  
LASER LEVELS

**Touch Free**

**Patented**



**Four Colors: Change Anytime**



## SWAY-3DG

360° Self-leveling Tri-Plane Green Laser Level with MOTION SENSOR

Technical Data	
Working Range	130ft(40m) 230ft (70m) Working Range with Receiver
Accuracy	±1/4 in @ 100 ft (2mm @ 10m)
Self-leveling Range	±3°
Laser Class/ Wavelength	Class II/520nm
Waterproof/ Dustproof	IP54
Power Supply	Li-ion Battery
Operating Temperature	14° F / -10° C ~ 104° F / 40° C
Incline Mode	Transport Lock & Individually Shiftable Function
Out-of-level-indication	Optical Signal and Audio Alert
Tripod Thread	1/4"



**Basic Package:**

- Laser x1
- Li-ion Battery x2
- Type-C USB
- Pouch bag



**Deluxe Package:**

- Laser x1
- Li-ion Battery x2
- Charger
- Type-C USB
- XYZ-axis Fine-tuning Base
- Hard Carrying Case



High Capacity Battery





**NEW**  
LASER LEVELS

## X Series: Heavy-duty Laser Levels for Professionals



Adjustable Magnetic Clamp



Magnetic Wall Mount



XYZ-Fine Tuning Base



Mountable Mini Tripod



Elevating Flooring Base

**NEW**  
LASER LEVELS

## X Series: Heavy-duty Laser Levels for Professionals

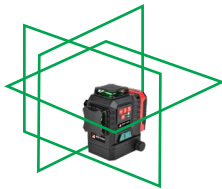

**XG12**

360° Self-leveling 3D Green Laser Level



**XG12F**

360° Self-leveling 3D Green Flooring Laser Level



**XG16**

360° Self-leveling 4D Green Laser Level

### Technical Data

Working Range	30m (70m with Receiver)
Accuracy	±2mm/10m
Self-leveling Range	±3°
Laser Class/ Wavelength	Class II Red 3D: 638nm Green 3D: 520nm
Waterproof/ Dustproof	IP54
Power Supply	Li-ion Battery
Operating Temperature	-10° C ~ 45° C
Incline Mode	Transport Lock & Individually Shiftable Function
Out-of-level-indication	Optical Signal and Audio Alert
Tripod Thread	1/4"



### Deluxe Package:

- Laser x1
- Li-ion Battery x1
- Charger
- XYZ-axis Fine-tuning Base
- Laser Target
- 1/4" Tread Mount
- Wall iron
- LMP-MK Magnetic Wall Mount
- Remote Control
- Hard Carrying Case

**NEW**  
LASER LEVELS

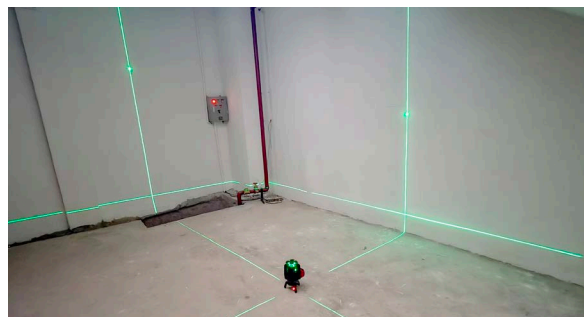

## XG800

4V4H5D Self-leveling 8 Line Green Laser Level

Technical Data	
Working Range	30m (70m with Receiver)
Accuracy	±2mm/10m
Self-leveling Range	±3°
Laser Class/ Wavelength	Class II Red 3D: 638nm Green 3D: 520nm
Waterproof/ Dustproof	IP54
Power Supply	Li-ion Battery
Operating Temperature	-10° C ~ 45° C
Incline Mode	Transport Lock & Individually Shiftable Function
Out-of-level-indication	Optical Signal and Audio Alert
Tripod Thread	1/4"



### Deluxe Package:

- Laser x1
- Li-ion Battery x2
- Charger
- Fine-tuning Base
- Laser Target
- Hard Carrying Case



High Capacity Battery



**NEW**  
LASER LEVELS

## Ultra Precision Motorized Laser

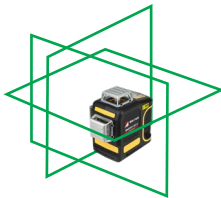

### BMOTO-3D-A

Motorized 360° Self-leveling 3D Green Laser Level



### BMOTO-3DF-A

Motorized 360° Self-leveling 3D Green Laser Level (Flooring)

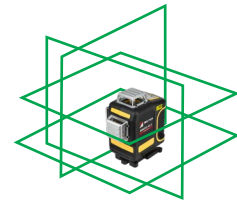

### BMOTO-4D-A

Motorized 360° Self-leveling 4D Green Laser Level

#### Technical Data

Working Range	130ft(40m) Indoor 230ft (70m) Working Range with Receiver
Accuracy	±0.75mm/5m
Self-leveling Range	±3°
Laser Class/ Wavelength	Class II 515nm/532nm/638nm ( Red/Green Available)
Waterproof/ Dustproof	IP54
Power Supply	18650 Li-ion Battery (KC Available)
Operating Temperature	-10° C ~ 45° C
Incline Mode	Transport Lock & Individually Shiftable Function
Out-of-level-indication	Optical Signal and Audio Alert
Tripod Thread	1/4"



#### Deluxe Package:

- Laser x1
- Li-ion Battery x1
- Type-C USB
- Charger
- XYZ-axis Fine-tuning Base
- Ceiling Wall Mount
- 1/4" Tread Mount
- Wall iron
- Elevating Flooring Base
- Remote Control
- Hard Carrying Case

**NEW**  
LASER LEVELS

## PACK-Series



**Powered by  
Clip-on Battery**

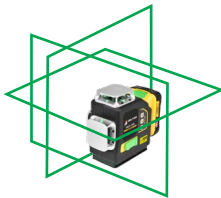

### PACK-3DG

360° Self-leveling 3D Green Laser Level

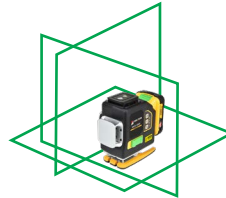

### PACK-3DGF

360° Self-leveling 3D Green Laser Level (Flooring)

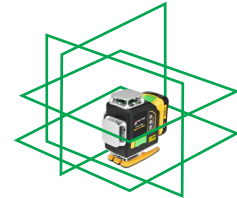

### PACK-4DG

360° Self-leveling 4D Green Laser Level

#### Technical Data

Working Range	30m (70m with Receiver)
Accuracy	±2mm/10m
Self-leveling Range	±3°
Laser Class/ Wavelength	Class II Red 3D: 638nm Green 3D: 532nm
Waterproof/ Dustproof	IP54
Power Supply	Li-ion Battery
Operating Temperature	-10° C ~ 45° C
Incline Mode	Transport Lock & Individually Shiftable Function
Out-of-level-indication	Optical Signal and Audio Alert
Tripod Thread	1/4"



#### Deluxe Package:

- Laser x1
- Li-ion Battery x1
- Type-C USB
- Charger
- 1/4" Tread Mount
- Remote Control
- Hard Carrying Case

**NEW**  
LASER LEVELS

## VS Series: Featuring Rotatable lenses

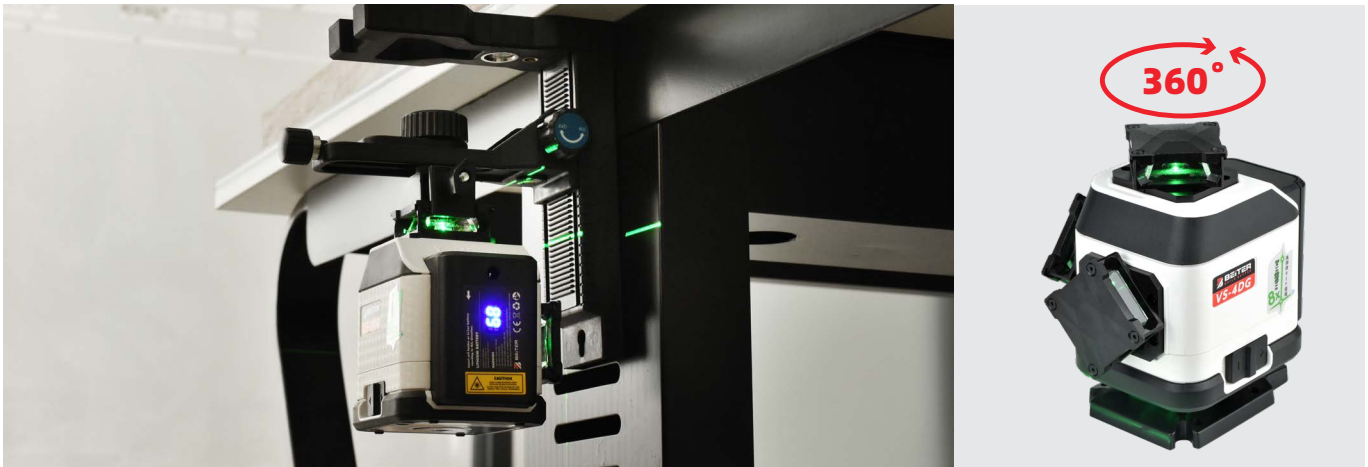

### VS-3DG

### VS-4DG

360° Green Flooring Laser Family - 2D/ 3D/ 4D/ Ceiling or Flooring laser

Technical Data	
Working Range	30m (70m with Receiver)
Accuracy	±2mm/10m
Self-leveling Range	±3°
Laser Class/ Wavelength	Class II 532nm/520nm
Waterproof/ Dustproof	IP54
Power Supply	3.7V Li-ion Battery/ 3 X AA Batteries/ Type-C Charger (AA Batteries Not Included In Some Countries)
Operating Temperature	-5° C ~ 50° C
Incline Mode	Transport Lock & Individually Shiftable Function
Out-of-level-indication	Optical Signal and Audio Alert
Tripod Thread	1/4"



**Includes:**

- Laser x1
- Li-ion Battery x1
- Charger
- Alkaline Battery Holder
- 3\*AA Alkaline Batteries
- XYZ-axis Fine-tuning Base
- Elevating Flooring Base
- Special Ceiling Wall Mount
- Wall Iron
- 5/8" to 1/4" Adaptor
- Remote Control
- Hard Carrying Case

**NEW**  
LASER LEVELS



**Palm-size**

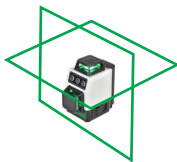

## TED-2D

Compact 360° Self-leveling  
Dual-plane Green Laser Level

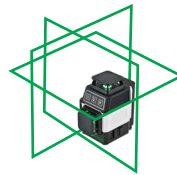

## TED-3D

Compact 360° Self-leveling  
Tri-plane Green Laser Level



## TED-4D

Compact 360° Self-leveling  
Quad-plane Green Laser Level

### Technical Data

Working Range	100ft(30m)
Accuracy	±1/4 in @ 100 ft (2mm @ 10m)
Self-leveling Range	±3°
Laser Class/ Wavelength	Class II/ 520nm
Waterproof/ Dustproof	IP54
Power Supply	Li-ion Battery
Operating Temperature	14° F / -10° C ~ 104° F / 40° C
Incline Mode	Transport Lock & Individually Shiftable Function
Out-of-level-indication	Optical Signal and Audio Alert
Tripod Thread	1/4"



### Deluxe Package:

- Laser x1
- Rechargeable Li-ion Battery x2
- Type-C USB
- Elevating Base
- Magnetic Wall Mount
- Padded Pouch Bag
- Color Box



**BART-3DG PRO**

Beiter Signature 3D Laser Level



**BART-3DGS**

The signature model accepts OEM design, Please contact us for further information.





## BART-3D PRO

360° Self-leveling Tri-plane Red Laser Level

## BART-3DG PRO

360° Self-leveling Tri-plane Green Laser Level



**Type C**  
EcoDesign With Type C Charging



**STRONG**  
Aluminium Window Frame



Technical Data	
Working Range	Red Laser: 100ft (30m) Green Laser: 130ft(40m) 230ft (70m) Working Range with Receiver
Accuracy	±1/4 in @ 100 ft (2mm @ 10m)
Self-leveling Range	±4°
Laser Class/ Wavelength	Class II Red Line: 660nm Green Line: 532nm
Waterproof/ Dustproof	IP54
Power Supply	3.7V Li-ion Battery/ 4 X AA Batteries/ Type-C Charger (AA Batteries Not Included In Some Countries)
Operating Temperature	14° F / -10° C ~ 104° F / 40° C
Incline Mode	Transport Lock & Individually Shiftable Function
Out-of-level-indication	Optical Signal and Audio Alert
Tripod Thread	1/4" & 5/8"



### Includes:

- Laser x1
- Li-ion Battery x1
- Alkaline Battery Holder x1
- Charger x1
- LMP-MK Magnetic Wall Mount
- Laser Target
- Hard Carrying Case
- Manual



## TIGE-3DG



Ultra Long Working Hour

360° Self-leveling Tri-Plane Green Laser Level

### Technical Data

Working Range	Red Laser: 100ft (30m), Green Laser: 130ft(40m), 230ft (70m) Working Range with Receiver
Accuracy	±1/4 in @ 100 ft (2mm @ 10m)
Self-leveling Range	±3°
Laser Class/ Wavelength	Class II, Red 3D: 660nm, Green 3D: 532nm
Waterproof/ Dustproof	IP54
Power Supply	Li-ion Battery
Operating Temperature	14° F / -10° C ~ 104° F / 40° C
Incline Mode	Transport Lock & Individually Shiftable Function
Out-of-level-indication	Optical Signal and Audio Alert
Tripod Thread	1/4"



### Includes:

- Laser x1
- Li-ion Battery x1
- Type-C USB
- LMP-MK Magnetic Wall Mount
- Hard Carrying Case



## LCG-021

Beiter Green Crossliner Pro



## LCG-031

Beiter Green Crossliner with 270° Wide Horizontal Laser Line



## LCG-041

Beiter Green Crossliner with 270° Wide Horizontal Laser Line and 2 Plumb Dots

### Technical Data

Working Range	Green Laser: 60ft(20m), 230ft (70m) Working Range with Receiver
Accuracy	±1/4 in @ 100 ft (2mm @ 10m)
Self-leveling Range	±3°
Laser Class/ Wavelength	Class II, Green Line: 510-520nm, Plumb dot: 650nm
Waterproof/ Dustproof	IP54
Power Supply	3.7V Li-ion Battery/ 4 X AA Batteries/ Type-C Charger (AA Batteries Not Included In Some Countries)
Operating Temperature	14° F / -10° C ~ 104° F / 40° C
Incline Mode	Transport Lock & Individually Shiftable Function
Out-of-level-indication	Optical Signal and Audio Alert
Tripod Thread	1/4"



### Includes:

- Laser x1
- Li-ion Battery x1
- Alkaline Battery Holder x1
- L-shaped Magnetic Wall Mount
- Type-C USB Line
- Pouch bag



**Includes:**

- Laser x1
- 3 X AA Batteries
- L-shaped Magnetic Wall Mount
- Type-C USB Line
- Pouch bag

## WAVE-3D1

360° Green Laser with Vertical Line

**Technical Data**

Working Range	Green Laser: 130ft(40m), 230ft (70m) Working Range with Receiver
Accuracy	±1/4 in @ 100 ft (2mm @ 10m)
Self-leveling Range	±3°
Laser Class/ Wavelength	Class II Green Line: 532nm
Waterproof/ Dustproof	IP54
Power Supply	3.7V Li-ion Battery/ 4 X AA Batteries/Type-C Charger (AA Batteries Not Included In Some Countries)
Operating Temperature	14° F / -10° C ~ 104° F / 40° C
Incline Mode	Transport Lock & Individually Shiftable Function
Out-of-level-indication	Optical Signal and Audio Alert
Tripod Thread	1/4"



**Includes:**

- Laser x 1
- Rechargeable Battery x 1
- Battery Case for Alkaline Battery
- Charger
- LWP-MK Magnetic Wall Mount
- Hard Carrying Case

## WAVE-10G/WAVE-10 Green/Red Laser Lines

Wide Horizontal and Two Vertical Linear Laser with Plumb Dot

**Technical Data**

Working Range	Red Laser: 32ft (10m)/Green Laser: 60ft(20m), 230ft (70m) Working Range with Receiver
Accuracy	±1/4 in @ 100 ft (2mm @ 10m)
Self-leveling Range	±4°
Laser Class/ Wavelength	Class II, Green Line: 510-520nm, Red Line: 635nm, Plumb Dot: 650nm
Waterproof/ Dustproof	IP54
Power Supply	3.7V Li-ion Battery/ 4 X AA Batteries/ DC Charger (AA Batteries Not Included In Some Countries)
Operating Temperature	14° F / -10° C ~ 104° F / 40° C
Incline Mode	Transport Lock & Individually Shiftable Function
Out-of-level-indication	Optical Signal and Audio Alert
Tripod Thread	1/4" & 5/8"

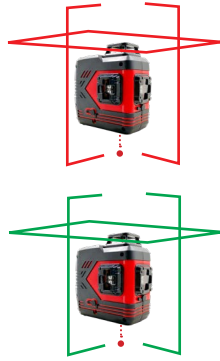

### Includes:

- Laser x1
- Li-ion Battery x1
- Alkaline Battery Holder x1
- Charger x1
- LMP-MK Magnetic Wall Mount
- Laser Target
- Hard Carrying Case

## BOX-CV2/CV2G

Beiter 360° with 2 Crossline Laser - Red/Green Beams

Technical Data	
Working Range	Red Laser: 100ft (30m), Green Laser: 130ft(40m), 230ft (70m) Working Range with Receiver
Accuracy	±1/4 in @ 100 ft (2mm @ 10m)
Self-leveling Range	±4°
Wavelength	Class II, Red Laser: 635-638nm, Green Laser: 532nm
Waterproof/ Dustproof	IP54
Power Supply	3.7V Li-ion Battery/ 4 X AA Batteries/ DC Charger (AA Batteries Not Included In Some Countries)
Operating Temperature	14° F / -10° C ~ 104° F / 40° C
Incline Mode	Transport Lock & Individually Shiftable Function
Out-of-level-indication	Optical Signal and Audio Alert
Tripod Thread	1/4" & 5/8"

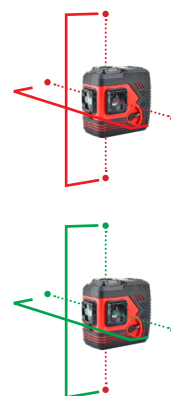
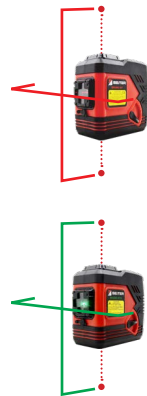

### Includes:

- Laser x1
- Li-ion Battery x1
- Alkaline Battery Holder x1
- Charger x1
- LMP-MK Magnetic Wall Mount
- Laser Target
- Hard Carrying Case
- Glasses

## BRUNO-XP/XPG

Self-leveling Crossline Red/Green Laser with Ceiling Point and Plumb Point

## BRODY-X4P/X4PG

Self-leveling 4-point Alignment Red/Green 2-in-1 Laser with 4 Points Plus A Cross-line Combo

Technical Data	
Working Range	Red Laser: 100 ft(30m) Indoor, Green Laser: 130 ft(40m) Indoor, 230ft (70m) Working Range with Receiver
Accuracy	±1/4 in @ 100 ft (2mm @ 10m)
Self-leveling Range	±4°
Laser Class/ Wavelength	Class II, Red Laser: 635nm For Line & Dots, Green Laser: 515nm For Line & Dots, 660nm For Plumb Point.
Waterproof/ Dustproof	IP54
Power Supply	3.7V Li-ion Battery/ 4 X AA Batteries/ DC Charger (AA Batteries Not Included In Some Countries)
Operating Temperature	14° F / -10° C ~ 104° F / 40° C
Incline Mode	Transport Lock & Individually Shiftable Function
Out-of-level-indication	Optical Signal and Audio Alert
Tripod Thread	1/4" & 5/8"

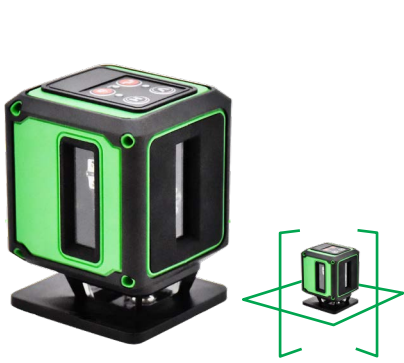

## BAJ-CV2G

Beiter Palm-sized Multi-Line Flooring Laser

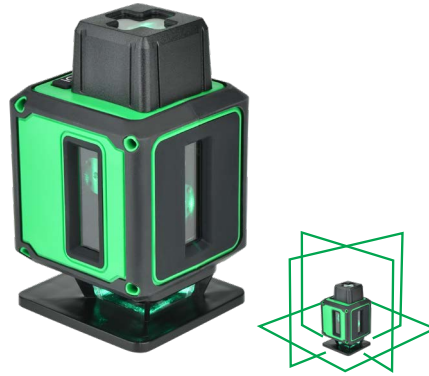

## BAJ-CX3G

Beiter Palm-sized Multi-Line Flooring Laser

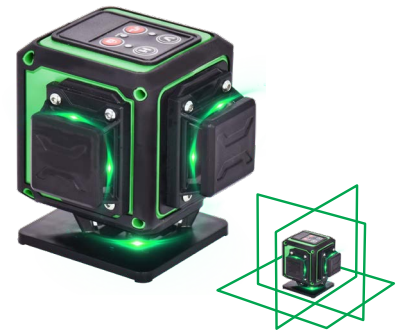

## BAJ-3DG

Beiter Palm-sized 3D Flooring Laser

### Technical Data

Working Range	Green Laser: 100 ft(30m) Indoor, 164ft (50m) Working Range with Receiver
Accuracy	±1/4 in @ 100 ft (2mm @ 10m)
Self-leveling Range	±3°
Laser Class/ Wavelength	Class II, Green Line: 510-540nm, Green Cone: 532/520nm
Waterproof/ Dustproof	IP54
Power Supply	3xAAx1.5V, or Li-ion Battery, DC Charger (Type-C USB Cable)
Operating Temperature	14° F / -10° C ~ 104° F / 40° C
Incline Mode	Transport Lock & Individually Shiftable Function
Out-of-level-indication	Optical Signal and Audio Alert
Tripod Thread	1/4"



### Includes:

- Laser x1
- Li-ion Battery x1
- 3 X AA Batteries
- USB Line
- Laser Target
- Pouch Bag
- Manual

## OEM

A Wide Range of Professional and DIY Models Available for OEM. Discuss with Our Reps for Customized Solutions.



## TED-L21

DIY Crossline Green Laser Level



Other OEM Look



## WG21

Crossline Green Laser Pro



## PT3DG-COMPACT

Palm-sized 3D Green Laser Pro

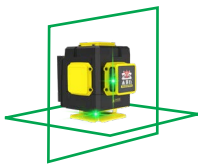

**MX2D**

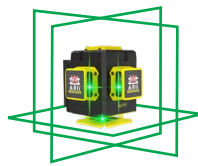

**MX3D**

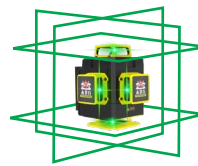

**MX4D**

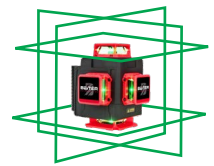

**BX-4D**

360° Green Flooring Laser Family - 2D/ 3D/ 4D/ Ceiling or Flooring laser

### Technical Data

Working Range	100 ft(30m)
Accuracy	±1mm/5m
Self-leveling Range	±4°
Wavelength	520nm
Waterproof/ Dustproof	IP54
Power Supply	Li-ion Battery
Operating Temperature	14° F / -10° C ~ 104° F / 40° C
Incline Mode	Transport Lock & Individually Shiftable Function
Out-of-level-indication	Optical Signal and Audio Alert
Tripod Thread	1/4"



### Includes:

- Laser x1
- Li-ion Battery x2
- Charger
- XYZ-axis Fine-tuning Base
- Elevating Flooring Base
- Special Ceiling Wall Mount
- 5/8" to 1/4" Adaptor
- Remote Control
- Hard Carrying Case

Other OEM Look:



**WT3DG-F**

3D Flooring Laser Pro

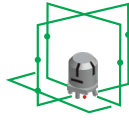

## LD-548

### Professional 5 Line Laser Level

Working Range	130 ft(40m) Indoor
Accuracy	±1/4 In @ 100 ft (2mm @ 10m)
Self-leveling Range	±3°
Laser Class/ Wavelength	Class II/ 520nm
Power Supply	2 X Li-ion Batteries/Dry Battery
Tripod Thread	5/8"

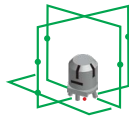

## ML-508

### Professional 5 Line Laser Level

Working Range	130 ft(40m) Indoor
Accuracy	±1/4 In @ 100 ft (2mm @ 10m)
Self-leveling Range	±3°
Laser Class/ Wavelength	Class II/ 532nm
Power Supply	Li-ion Battery/DC Charger
Tripod Thread	5/8"

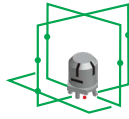

## ML-5G

### Professional 5 Line Laser Level

Working Range	130 ft(40m) Indoor
Accuracy	±1/4 In @ 100 ft (2mm @ 10m)
Self-leveling Range	±3°
Laser Class/ Wavelength	Class II/ 532nm
Power Supply	Li-ion Battery/DC Charger
Tripod Thread	5/8"

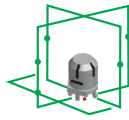

## G4168

### Professional 5 Line Laser Level

Working Range	130 ft(40m) Indoor
Accuracy	±1/4 In @ 100 ft (2mm @ 10m)
Self-leveling Range	±3°
Laser Class/ Wavelength	Class II/ 532nm
Power Supply	Li-ion Battery/DC Charger
Tripod Thread	5/8"

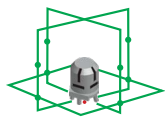

## WT-240G

### 4V4H9D Green Line Laser Level Electronic Automatic System Self-Leveling

Working Range	130 ft(40m) Indoor
Accuracy	±1/4 In @ 100 ft (2mm @ 10m)
Self-leveling Range	±3°
Laser Class/ Wavelength	Class II/ 532nm
Power Supply	Li-ion Battery/DC Charger
Tripod Thread	5/8"



- Ultra-bright green laser points and lines.
- For horizontal leveling, vertical alignment, squaring, layout, and plumb point transfer.

## BMOTO-8G

Beiter 8-line Green Motorized Laser System

### Technical Data

Working Range	130ft(40m) Indoor 230ft (70m) Working Range with Receiver
Accuracy	±1/4 in @ 100 ft (2mm @ 10m)
Self-leveling Range	±3°
Laser Class/ Wavelength	Class II Green Line: 510-540nm Plumb Dot: 650nm
Waterproof/ Dustproof	IP54
Power Supply	3.7V Li-ion Battery/ 4 X AA Batteries/ DC Charger (AA Batteries Not Included In Some Countries)
Operating Temperature	14° F / -10° C ~ 104° F / 40° C
Incline Mode	Transport Lock & Individually Shiftable Function
Out-of-level-indication	Optical Signal And Audio Alert
Tripod Thread	5/8"



### Includes:

- Laser x1
- Li-ion Battery x1
- Charger
- 4\*AA alkaline batteries
- Laser Target
- Hard Carrying Case



**NEW**  
LASER LEVELS



## RR3605/3615/3625 GR3605/3615/3625

Self-leveling Red/Green Beam Rotary Laser Level with Robust Housing Design

### Variations(Also Available in Red)

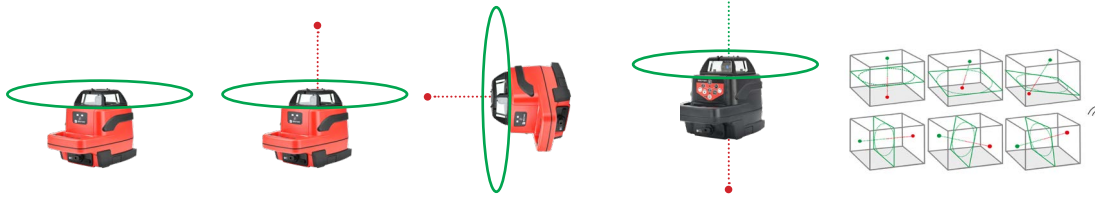

**3605**

**3615**

**3625**

Technical Data	
Laser Features	Motorised Horizontal and Vertical Scanning
Working Range(Diameter)	800m; Receiver up to 400m
Accuracy	Horizontal $\pm 20''$ ( $\pm 10\text{mm}/100\text{m}$ ) vertical $\pm 30''$ ( $\pm 15\text{mm}/100\text{m}$ )
Self-leveling Range	$\pm 5^\circ$
Laser Class/Wavelength	Class 3R 635nm-7mw For Red Laser 520nm-30mw For Green Laser
Rotating Speed*	600Rpm/ *#3615: Adjustable speed at 0/150/300/600Rpm
Water Proof/Dustproof Rating	IP66
Vertical Laser Scanning	360° (#3615,#3625)
Tripod Thread	5/8"
Power Supply	2x18650 Li-ion Batteries
Operating Hours	Red: 35-38hrs Green: 23-25hrs
Operating Temperature	Red Laser: $-10^\circ\text{C}$ - $45^\circ\text{C}$ Green Laser: $-10^\circ\text{C}$ - $50^\circ\text{C}$
Weight(With Battery)	1583g
DC Charger	Yes
Out-of-level Indication	Only Available w/#3625
Incline Mode	Only Available w/#3625



### Includes:

- Laser x1
- 2x18650 Li-ion Batteries
- Charger
- Type-C USB
- Laser Intensive Glasses
- Laser Receiver with Clamp
- Hard Carrying Case

**NEW**  
LASER LEVELS

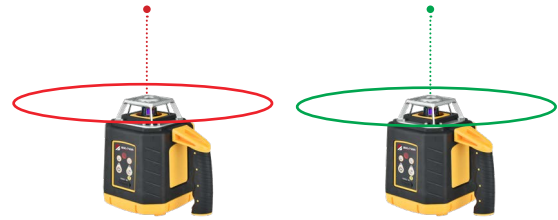

Remote Control

Laser Receiver

## RR3604/GR3604

Self-leveling Red/Green Beam Rotary Laser Level

### Technical Data

Laser Features	Motorised Horizontal and Vertical Scanning
Working Range with Receiver	Red Laser: 400m(Diameter) Green Laser: 500m(with Laser Detector)
Accuracy	±1/16" @100ft.(±0.05mm/m)
Self-leveling Range	±8°
Laser Class/Wavelength	Class 3R 635nm-7mw For Red Laser 520nm-30mw For Green Laser
Water Proof/Dustproof Rating	IP66
Horizontal Laser Angle	360°
Vertical Laser Angle	360°
Tripod Thread	5/8"
Power Supply	Alkaline Batteries
Operating Temperature	Red Laser: -10° c-45° c Green Laser: -10° c-50° c
Weight(With Battery)	1656g
DC Charger	Yes
Out-of-level Indication	Optical Signals
Incline Mode	Yes



### Includes:

- Laser x1
- Laser Receiver with Clamp
- Hard Carrying Case
- Alkaline Batteries
- Remote Control
- Manual

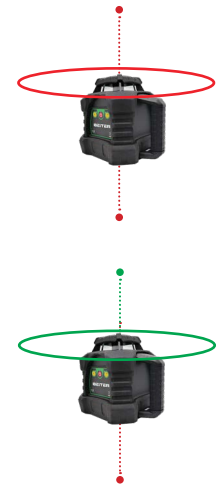
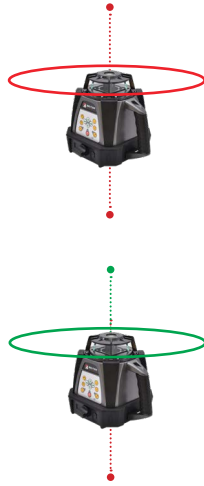

## RR3602/GR3602

Beiter Motorized Dual-direction Rotating Lasers

## RR3603/GR3603

Self-leveling Red/Green Beam Rotary Laser Level with Robust Housing Design

Technical Data	RR3602/GR3602	RR3603/GR3603
Laser Features	Motorised Horizontal and Vertical Scanning	Motorised Horizontal and Vertical Scanning
Working Range With Receiver	Red Laser: 500m(Diameter) Green Laser: 800m(Diameter)	Red Laser: 500m(Diameter) Green Laser: 800m(with Laser Detector)
Accuracy	±1/16"@100ft.(±0.05mm/m)	±1/16"@100ft.(±0.05mm/m)
Self-leveling Range	±5°	±8°
Laser Class/Wavelength	Class 3R 635nm For Red Laser 532nm For Green Laser	Class 3R 635nm For Red Laser 532nm For Green Laser
Water Proof/Dustproof Rating	IP65	IP66
Horizontal Laser Angle	360°	360°
Vertical Laser Angle	360°	360°
Tripod Thread	5/8"	5/8"
Power Supply	4x Ni-MH Rechargeable Batteries	4x Ni-MH Rechargeable Batteries
Operating Temperature	Red Laser: -10° c-45° c Green Laser: -10° c-50° c	Red Laser: -10° c-45° c Green Laser: -10° c-50° c
DC Charger	Yes	Yes
Out-of-level Indication	Optical Signals	Optical Signals
Incline Mode	Yes	Yes

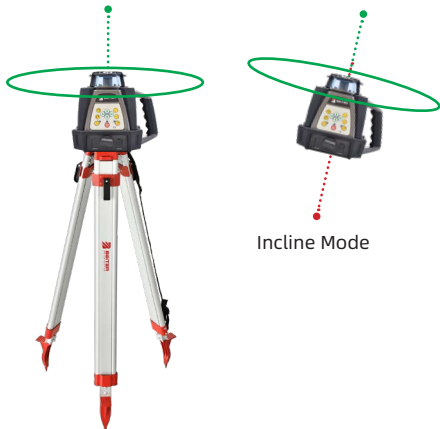

Incline Mode

2 Plumb Dots



### Includes:

- Laser x1
- Charger
- Laser Target
- Laser Intensive Glasses
- Laser Receiver with Clamp
- Remote Control
- Hard Carrying Case



## BOL-32X

Beiter 32X Automatic Optical Level

Technical Data	
Model No.	32X
Image	Erect Image
Objective Aperture	≥ 42mm
Min.focusing Distance	0.3mm
Stadia Multiplication Constant	100
Stadia Additive Constant	0
Resolution	≤ 4"
Working Range	15'
Compensating Error	≤ ±0.3"/1'
Setting Accuracy	≤ ±0.5"
Scale Graduation Range	360° /400G
Scale Minimum Value	1" /1gon
GO/RE Observation Error	±2mm/km
Sensitivity of Circular Bubble	8'/2mm
Base Screw	M16 or 5/8" X1/11" (Optional)
Environmental Temperature	-25°C to 50°C

### Includes:

- Automatic Optical Level
- Plumb Bob
- Hard Carrying Case
- Tool Kit

### The Most Accurate Optical Level on Site

- Flexibility - The BOL series is designed for all types of surveying tasks, including routine leveling on construction sites, check or monitor buildings, railways or roads.
- Highest accuracy and reliability. The top-class optical quality of Beiter Laser System delivers a high contrast image and precise reading even under unfavorable light conditions.
- High temperature stability and fast set-up-Use the coarse movement of the focusing knob for rapid setting with minimum turning. Fine movement gives final touch a perfect image.



## DLD802

Professional Laser Receiver

Technical Data	
Leveling Accuracy (High)	1mm
Leveling Accuracy (Normal)	2mm
Leveling Accuracy (Low)	5mm
Laser Reception Window Width	130mm
Working Radius	≤ 350m
Bubble Vial Accuracy	30'/3nm
Operation Time	24h (No LCD Back Light)
Auto Power Off(with NO Signal Detected)	30min
Power Supply	4 X AA Batteries (Alkaline)
IP Rating	IP56
Operating Temperature Range	-10° C~50° C
Storage Temperature Range	-20° C~70° C

- **LR-70** Suits All Beiter Red Construction Professional Linear Lasers with Detector Mode.
- **LR-90G** Suits All Beiter Green Lasers in 275HZ Frequency with Detector Mode.
- **LR-10GS** Suits All Beiter Green Lasers in 5k HZ Frequency with Detector Mode.



**LR-70**  
Laser Receiver with Clamp



**LR-90G**  
Laser Receiver with Clamp



**LR-10GS**  
Laser Receiver with Clamp

- Led Light Indicator
- Sensor Panel and Speaker
- Best Within 1-70m (5-220ft) Range

## LASER DISTANCE METER



**NEW**  
Measuring



**NEW**  
Measuring



### BR-X SERIES

Model	BR-X80G/100G	BR-X40/60/80
Accuracy	±2 mm	±2 mm
Laser Class	2 (<1 mW 510-530nm)	2 (<1 mW 620-690nm)
Operating Distance	0.05-80m/100m	0.05-40m/60m/80m
Operating Temperature	0-40°C	0-40°C
Power Source	3 × 1.5V AAA	3 × 1.5V AAA
Memory Record	99 Units	99 Units
Weight (Including Battery)	92g	92g
Dimension	120 x 50 x 25mm	120 x 50 x 25mm
The Laser Automatically Shuts off	30 seconds	30 seconds

### Features

- Measures Distance, Area, Volume, and Pythagoras
- Addition and Subtraction Function
- Backlit LCD Screen
- Delayed Measurement Function
- Continuous Measurement Tracking
- Auto Power Off



### Includes

- Laser Distance Meter x1
- Power Supply AAA x3
- Portable Bag x1
- Hand Strap x1
- User's Manual x1

## LASER DISTANCE METER



### BR-T40/60/80

Technical Data	
Accuracy	±2 mm
Laser Class	2 (<1 mW 635 nm)
Operating Distance	0.05-40m/60m/80m
Operating Temperature	0-40°C
Max Storage	30 Units
Power Source	2 x 1.5V AAA
Memory Record	100 Measurements
Weight (Including Battery)	110g
Dimension	112 x 50 x 25mm
The Laser Automatically Shuts off	60 seconds

### Features

- Measures Distance, Area, Volume, and Pythagoras
- Addition and Subtraction Function
- Backlit LCD Screen
- Delayed Measurement Function
- Continuous Measurement Tracking
- Auto Power Off

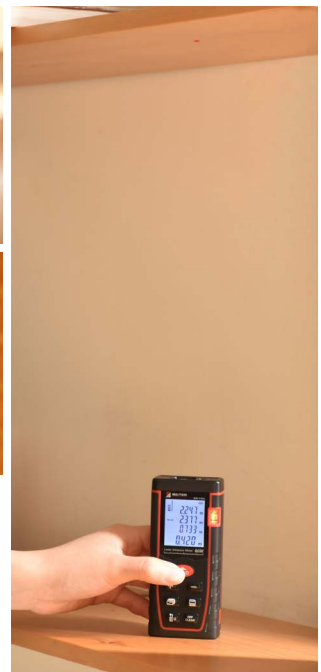

### Includes

- Laser Distance Meter x1
- Power Supply AAA x2
- Portable Bag x1
- Hand Strap x1
- User's Manual x1

## Beiter Measuring Tape



<b>BT-5019</b>	
Tape Length	5M
Tape Width	19mm
Tape Thickness	0.115mm
Metric/ Imperial Markings	



<b>BT-5525</b>	
Tape Length	5.5M
Tape Width	25mm
Tape Thickness	0.115mm
Metric/ Imperial Markings	



<b>BT-7525</b>	
Tape Length	7.5M
Tape Width	25mm
Tape Thickness	0.115mm
Metric/ Imperial Markings	



<b>BT-5527</b>	
Tape Length	5.5M
Tape Width	27mm
Tape Thickness	0.165mm
Metric/ Imperial Markings with Magnet	



<b>BT-8027</b>	
Tape Length	8M
Tape Width	27mm
Tape Thickness	0.165mm
Metric/ Imperial Markings with Magnet	

## Acrow Props Support System

**NEW**



### SPECIFICATIONS

Model No.	Ref No.	Min Height	Max Height	Unit Weight	Max Weight Capacity
AP1100	Puntal 0	40cm	60cm	1.10kg	450kg
AP1101	Puntal 1	60cm	100cm	1.36kg	450kg
AP1102	Puntal 2	95cm	170cm	1.38kg	450kg
AP1103	Puntal 3	155cm	290cm	2.61kg	210~450kg
AP1104	Puntal 4	200cm	375cm	3.18kg	70~450kg



Min Height

Max Height

Model No.	AP1100	AP1101	AP1102	AP1103	AP1104
Ref No.	Puntal 0	Puntal 1	Puntal 2	Puntal 3	Puntal 4
40cm	450kg				
60cm	450kg	450kg			
100cm		450kg	450kg		
155cm			450kg	450kg	
170cm			300kg	450kg	
200cm				450kg	450kg
250cm				220kg	350kg
290cm				150kg	210kg
300cm					200kg
325cm					150kg
350cm					90kg
cm					70kg

Length

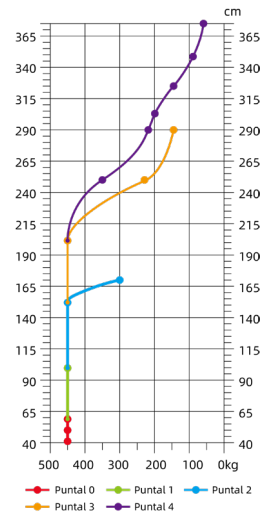





## LWP-MK *Patented*

Versatile "Yoga" Magnetic Wall Mount

One-button Quick Change Screw



Available for 1/4" or 5/8" Thread



### 5 KEY BREAKTHROUGH!

1. Interchangeable 1/4" and 5/8" thread\*  
(Ship with 1/4" by default, 5/8" at request)
2. Mount to a tripod to function as a reclining tripod.
3. Super heavy duty with rare earth magnet. Max. weight: 10lbs
4. Flexible angle adjustment
5. Extended length for extra support.  
(can lift a rotary laser)



One-button Quick Change Screw



## LWP-MJ *Patented*

L-shaped Magnetic Wall Mount, 1/4" Thread



## L-Clamp

Multi-angle Base  
1/4" Adaptor



## LB-FRB1

Fine-tuning Rotating Base, 1/4" Thread  
Rotates 360° by the precision of a fine adjustment knob, while staying centered on the plumb point



## L213B-RB

Rotating Base with Angle Scale  
5/8" Thread



## LWP-PMX

Heavy Duty Magnetic Rotating Wall Mount  
5/8" Thread



### LSP00801

Heavy Duty Laser Level Ceiling Mounting Bracket, 1/4" Thread



### LSP-401

Magnetic Elevating Wall Mount, 1/4" Thread



### LSP10002

5/8" Incline Bracket



## NEW Robust Laser Tripod

### T145/ T160MX-INC/ T180MX-IN

Premium Industrial Grade Aluminum Elevating Tripod with Sturdy Horseshoe™ foot, 5/8" (Can be supplied with 1/4" adaptor, or incline adaptor. Ask our reps.)

**NEW**



# Professional Tripods

## T102/ T120/ T150

1m/1.2m/1.5m  
 Aluminum Elevating Tripod, 5/8"  
 (Can be supplied with 1/4" adaptor,  
 or incline adaptor. Ask our reps.)



## BTSTAFF-LR

2.4 meter Laser Rod

- 2.4m Adjustable height grade rod for operation over various inclines
- Attached bubble vial for accurate setting of graderod
- Sliding detector mount for increased speed and accuracy of readings



## BE-STAFF(3M/ 5M)

Telescopic Leveling Staff  
 E-face 5m 5-section Staff  
 0.5cm-face 5m 5-section staff

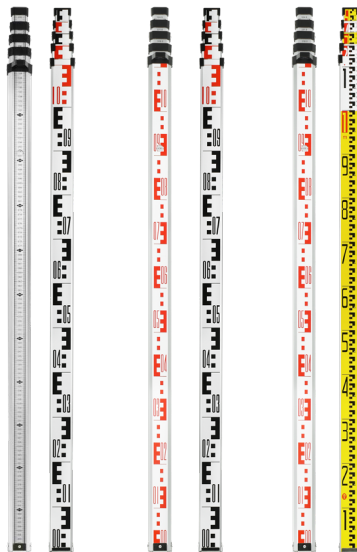

## BTP-37S

Beiter 3.7m Adjustable  
 Telescoping Pole  
 with Tripod

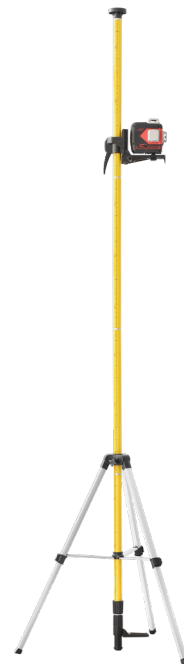

# Aluminum Surveying Tripod



## BT160FH/DH

### EXTENDABLE

The Beiter BT160FH/DH tripod provides extendable height adjustments so the user can expand tripod up to 63 inches for different height applications.

### ADJUSTABLE

The tripod features a steady adjustable base that swivels, adjusts, and tightens product for steady measurement applications.

### PORTABLE

The Beiter BT160FH/DH is portable and lightweight with collapsible legs and built-in strap. At only 8 lbs. the tripod is easy to store and transport.

### STABILITY

The Beiter BT160FH/DH tripod provides an adjustment system that tightens the tripod for increased stability at the user's desired height.

### VERSATILE

Industry standard 5/8-inch x 11 mounting threads with both flat head and domed head design, the Beiter BT160FH/DH is universal with a string hook for plumb bobs as well.

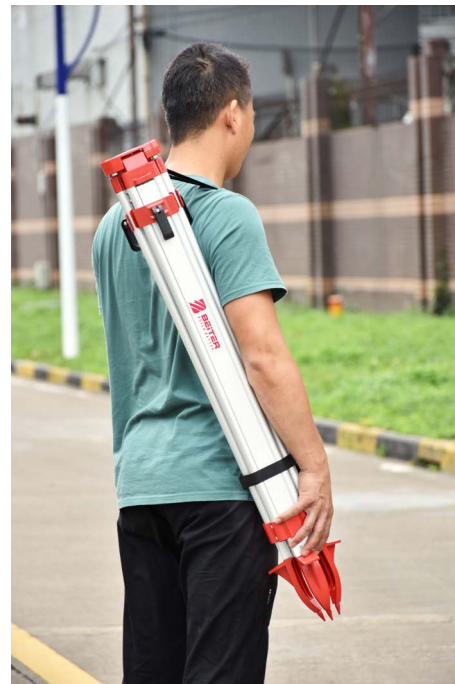

# Aluminum Surveying Tripod

**Model: BT160**

### Technical Data

Closed Height	38in.(97cm)
Extended Height	63in.(160cm)
Material	Aluminum
Weight	8 lbs

### LIGHTWEIGHT AND DURABLE

Aluminum Design hinges, clamps and shoe casting

### PAINTED SHOE CASTING

For durable and long lasting finish



### QUICK-CLAMP RELEASE

Allows easy setup and take-down

### ELECTROSTATIC POWER-PAINTED CASTING

Provides a durable, long-lasting finish



**BT160FH**  
FLAT HEAD TRIPOD



**BT160DH**  
DOME HEAD TRIPOD

### FLAT, DOME, ELEVATOR HEAD TYPE

With standard 5/8-inch x 11 mounting threads

### EXTENDABLE HEIGHT

65 in. extended height

### STRING HOOK

For a plumb bob

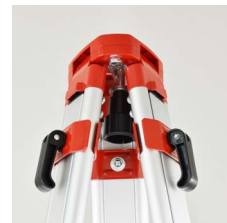

# INDUSTRIAL GRADE HIGH TORQUE POWER TOOLS



# One platform shared by multiple machines

Combine as you like, giving you unlimited flexibility in your choice of tools, batteries and chargers.



## A new generation of battery systems

Our innovative battery platform guarantees maximum flexibility and optimum performance. Lithium-ion batteries are easily interchangeable with various 21V power tools.

- Saving cost**
- Output strong**
- Intelligent Protect**
- Battery life lasting**



Battery capacity:	2000mAh	4000mAh	6000mAh
Charging time:	1.2H	2.4H	3.6H
Battery weight:	0.5kg	0.7kg	1kg

**MULTIPLE INTELLIGENT PROTECTION LONGER LIFE**

- A** Overcurrent Protection
- X** Short circuit protection
- ⚡** Overload protection
- 🌡️** Over temperature protection

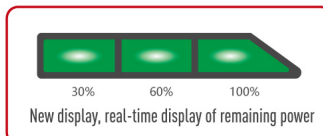

## BT420-12V

### 12V Cordless 2 Speed Drill

Rated Voltage	12V
Battery Capacity	2.0Ah
No Load Speed	0-350/1350 rpm
Chuck Size	10mm
Max Torque	28Nm
Torque Setting	16+1
Drilling Capacity	Wood 21mm/Steel 10mm
Weight	1Kg(bare)
Accessories	2x Li-ion Batteries, Charger, Tool Bag



## BT430-12V

### 12V Cordless 2 Speed Drill with Brushless Motor

Rated Voltage	12V
Battery Capacity	2.0Ah
No Load Speed	0-450/1400rpm
Chuck Size	10mm
Max Torque	36Nm
Torque Setting	20+1
Drilling Capacity	Wood 20mm/Steel 10mm
Weight	0.88Kg(bare)
Accessories	2x Li-ion Batteries, Charger, Tool Bag



## BM418-12V

### 12V Cordless Impact Driver

Rated Voltage	12V
Battery Capacity	2.0Ah
No Load Speed	0-2600rpm
Impact Rate	0-3000bpm
Collet Size	6.35mm(1/4") Hex
Max Torque	100Nm
Weight	1Kg(bare)
Accessories	2x Li-ion Batteries, Charger, Tool Bag



## C12-2B1 12V COMBO KIT

Item No.	BT420-12V	BM418-12V
Rated Voltage	12V	12V
Battery Capacity	2.0Ah	2.0Ah
No Load Speed	0-350/1350rpm	0-2600rpm
Chuck Size	10mm	6.35mm(1/4") Hex
Impact Rate	/	0-3000bpm
Max Torque	28Nm	100Nm
Torque Setting	16+1	/
Drilling Capacity	Wood 21mm/ Steel 10mm	/
Weight	1Kg(bare)	1Kg(bare)
Accessories	2x Li-ion Batteries, Charger, Tool Box	

BT420-12V

BM418-12V



Accessories





## BT530-16V

### 16V Cordless 2 Speed Drill with Brushless Motor

Rated Voltage	16V
Battery Capacity	2.0Ah
No Load Speed	0-500/1700rpm
Chuck Size	10mm
Max Torque	60Nm
Torque Setting	20+1
Drilling Capacity	Wood 20mm/ Steel 10mm
Weight	0.8Kg(bare)
Accessories	2x Li-ion Batteries, Charger, Tool Bag



\* BT532-16V  
With Impact



**NEW**

## BT430-16V

### 16V Cordless 2 Speed Drill with Brushless Motor

Rated Voltage	16V
Battery Capacity	2.0Ah
No Load Speed	0-500/1500rpm
Chuck Size	10mm
Max Torque	40Nm
Torque Setting	20+1
Drilling Capacity	Wood 20mm/ Steel 10mm
Weight	0.8Kg(bare)
Accessories	2x Li-ion Batteries, Charger, Tool Bag



## BT432-16V

### 16V Cordless Hammer Drill with Brushless Motor

Rated Voltage	16V
Battery Capacity	2.0Ah
No Load Speed	0-500/1500rpm
Impact Rate	0-1100/3200bpm
Chuck Size	10mm
Max Torque	40Nm
Torque Setting	20+1+1
Drilling Capacity	Wood 20mm/ Steel 10mm/ Concrete 8mm
Weight	0.8Kg(bare)
Accessories	2x Li-ion Batteries, Charger, Tool Bag



## BT420-16V

### 16V Cordless 2 Speed Drill

Rated Voltage	16V
Battery Capacity	2.0Ah
No Load Speed	0-450/1650 rpm
Chuck Size	10mm
Max Torque	32Nm
Torque Setting	16+1
Drilling Capacity	Wood 20mm/ Steel 10mm
Weight	1.1Kg(bare)
Accessories	2x Li-ion Batteries, Charger, Tool Bag



## BM418-16V

### 16V Cordless Impact Driver

Rated Voltage	16V
Battery Capacity	2.0Ah
No Load Speed	0-2600rpm
Impact Rate	0-3100bpm
Collet Size	6.35mm (1/4") Hex
Max Torque	107Nm
Weight	1.1Kg(bare)
Accessories	2x Li-ion Batteries, Charger, Tool Bag



## BM428-16V

### 16V Cordless Impact Driver Pro. (Brushless)

Rated Voltage	16V
Battery Capacity	2.0Ah
No Load Speed	0-3000rpm
Impact Rate	0-3300bpm
Chuck	1/4 in.(6.35mm)
Max Torque	130Nm
Weight	1.3kg(bare)
Accessories	2x Li-ion Batteries, Charger, Tool Bag



## BC280-16V

### 16V Cordless Hammer Drill

Rated Voltage	16V
Battery Capacity	2.0Ah
No Load Speed	0-450/1600rpm
Impact Rate	0-3200bpm
Chuck Size	10mm
Max Torque	32Nm
Torque setting	16+1+1
Drilling capacity	Wood 20mm/ Steel 10mm
Weight	1.3kg(bare)
Accessories	2x Li-ion Batteries, Charger, Tool Bag



## C16-2B1 16V COMBO KIT

Item No.	BT420-16V	BM418-16V
Rated Voltage	16V	16V
Battery Capacity	2.0Ah	2.0Ah
No Load speed	0-450/1650rpm	0-2650rpm
Chuck Size	10mm	6.35mm (1/4") Hex
Impact Rate	/	3100 bpm
Max Torque	32Nm	107Nm
Torque Setting	16+1	/
Drilling Capacity	Wood 25mm/Steel 10mm	/
Accessories	2x Li-ion Batteries, Charger, 2x Drill, Tool Box	

### BT420-16V

### BM418-16V



### Accessories



## C16-4B1 16V Brushless POWER COMBO KIT

Item No.	BT430-16V BL	BT432-16V BL
Rated Voltage	16V	16V
Battery Capacity	2.0Ah	2.0Ah
No Load Speed	0-500/1500rpm	0-500/1500rpm
Chuck Size	10mm	10mm
Impact Rate	/	0-1100/3200bpm
Max Torque	40Nm	40Nm
Torque Setting	20+1	20+1+1
Drilling Capacity	Wood 20mm/Steel 10mm	Wood 20mm/Steel 10mm/ Concrete 8mm
Accessories	2x Li-ion Batteries, Charger, Tool Box	

### BT430-16V

### BT432-16V



### Accessories



## BT421-20V

### 20V Cordless 2 Speed Drill

Rated Voltage	20V
Battery Capacity	2.0Ah
No Load Speed	0-450/1600rpm
Chuck Size	10mm
Max Torque	45Nm
Torque Setting	16+1
Drilling Capacity	Wood 30mm/Steel 10mm
Weight	1.3kg(bare)
Accessories	2x Li-ion Batteries, Charger, Tool Bag



## BC280-20V

### 20V Cordless Hammer Drill

Rated Voltage	20V
Battery Capacity	2.0Ah
No Load Speed	0-450/1650rpm
Impact Rate	0-3400bpm
Chuck Size	10mm
Max Torque	45Nm
Torque setting	16+1+1
Drilling capacity	Wood 21mm/ Steel 10mm/ Concrete 8mm
Weight	1.3kg(bare)
Accessories	2x Li-ion Batteries, Charger, Tool Bag



## BT430-20V

### 20V Cordless 2 Speed Drill with Brushless Motor

Rated Voltage	20V
Battery Capacity	2.0Ah
No Load Speed	0-450/1800rpm
Chuck Size	10mm
Max Torque	45Nm
Torque Setting	20+1
Drilling Capacity	Wood 30mm/Steel 12mm
Weight	1.3kg(bare)
Accessories	2x Li-ion Batteries, Charger, Tool Bag



## BT432-20V

### 20V Cordless Hammer Drill with Brushless Motor

Rated Voltage	20V
Battery Capacity	2.0Ah
No Load Speed	0-450/1800rpm
Impact Rate	0-1050/3400bpm
Chuck Size	10mm
Max Torque	45Nm
Torque Setting	20+1+1
Drilling Capacity	Wood 30mm/Steel 12mm/ Concrete 10mm
Weight	1.27kg(bare)
Accessories	2x Li-ion Batteries, Charger, Tool Bag



## BL55M

### 20V Cordless Impact Driver with Brushless Motor

Rated Voltage	20V
Battery Capacity	5.0Ah
No Load Speed	0-1900/2500rpm
Impact Rate	0-2200/3000bpm
Chuck Size	6.35mm(1/4") Hex
Max Torque	175Nm(1550 in-lbs.)
Weight	1.6kg(bare)
Accessories	2x Li-ion Batteries, Charger, Tool Bag



## BL65W

### 20V Cordless Impact Wrench with Brushless Motor

Rated Voltage	20V
Battery Capacity	5.0Ah
No Load Speed	0-1900/2500rpm
Impact Rate	0-2200/3000bpm
Chuck Size	12.7mm(1/2")
Max Torque	310Nm
Weight	1.7kg(bare)
Accessories	2x Li-ion Batteries, Charger, Tool Bag



## BL30SC

### 20V Cordless Pruning Scissors with Brushless Motor

Max Cut Diameter	30mm
Rated Voltage	20v
Rated Power	150w
Adjustable Opening	√
Cut Protection	Optional
Safety Switch	√
Display Panel	√
Lubricant Oil Port	√
Stepless Speed Change	√
Rapid Charge	√
Antilocking	√
Blade Quality	SK5
Motor Type	Conventional Brush Motor
Non-Slip Handle	√



## BA618-20V

### 20V Cordless Angle Grinder With Brushless Motor

Rated Voltage	20V
Battery Capacity	5.0Ah
No Load Speed	10000rpm
Dia. of Grinding Wheel	100mm
Dia. of Hole	16mm
Spindle Thread	M10
Weight	1.4kg
Accessories	2x Li-ion Batteries, Charger





## BRH60-20V

20V Cordless Rotary Hammer With Brushless Motor

Rated Voltage	20V
Battery Capacity	5.0Ah
No Load Speed	0-1450rpm
Impact Rate	0-4500bpm
Impact Energy	2.2J
Drilling Capacity	Wood 22mm/ Steel 13mm/ Concrete 22mm
Chuck Size	8-12mm
Weight	2.6kg
Accessories	2x Li-ion Batteries, Charger, Tool Box



## BRH70-20V

20V Cordless Brushless Rotary Hammer Drill

Rated Voltage	20V
Battery Capacity	5.0Ah
No Load Speed	0-1600rpm
Impact Rate	0-4500bpm
Impact Energy	2.0J
Drilling Capacity	Wood 28mm/ Steel 13mm/ Concrete 22mm
Chuck Size	8-12mm
Charging Time	100 minutes
Weight	2.6kg(bare)
Accessories	2x Li-ion Batteries, Charger



## R20-RHA 20V Brushless POWER COMBO KIT

Item No.	BA618-20V	BRH60-20V
Rated Voltage	20V	20V
Battery Capacity	5.0Ah	5.0Ah
No Load Speed	10000rpm	0-1450rpm
Dia. of Grinding Wheel	100mm	/
Dia. of Hole	16mm	/
Spindle Thread	M10	/
Impact Rate	/	0-4500bpm
Impact Energy	/	2.2 Joules
Drilling Capacity	/	Wood 22mm/ Steel 13mm/ Concrete 22mm
Chuck Size	/	8-12mm
Weight	1.4kg	2.6kg
Accessories	2x Li-ion Batteries, Charger, Tool Bag	

### BRH60-20V



### BA618-20V



### A21221P 12V

Battery Voltage	12V
Battery Capacity	2.0Ah
Power	24Wh



### A21221P 16V

Battery Voltage	16V
Battery Capacity	2.0Ah
Power	32Wh



### A218201P

Battery Voltage	20V
Battery Capacity	2.0Ah
Power	40Wh



### A218502P

Battery Voltage	20V
Battery Capacity	5.0Ah
Power	100Wh



### T1215C 12V

For Use With	A21221P 12V
Charging Time	80min



### T1615C 16V

For Use With	A21221P 16V
Charging Time	80min



### D1820H

A218201P 20V	A21221P 16V
60min (2.0Ah)	80min



### Y1830H

A218201P 20V	A218502P 20V
60min (2.0Ah)	80min (5.0Ah)

## BT-26SRE850

### 850W 3 FUNCTION SDS+ Rotary Hammer

Rated Voltage	240V/50Hz
Drilling Capacity	Wood 22mm/ Steel 13mm/ Concrete 26mm
Impact Rate	0-4800bpm
Rated Input Power	850W
No Load Speed	0-1300rpm
Impact Energy	3.2j



## BT-26SRE950

### 950W 3 FUNCTION SDS+ Rotary Hammer

Rated Voltage	240V/50Hz
Drilling Capacity	Wood 32mm/ Steel 13mm/ Concrete 30mm
Impact Rate	0-4800bpm
Rated Input Power	950W
No Load Speed	0-1300rpm
Impact Energy	3.3j





## BVS08

### 20V Brushless Stick Vacuum Cleaner Kit

Rated Voltage	20V
Battery Capacity	5.0Ah
No Load Speed	100000rpm
Suction Power	120Aw
Max Suction	20kPa
Tank Capacity	900ml
Max Running Time	60mins
Accessories	Li-Ion Battery, Charger, Wall-Mounted Dock, Handheld Components, Extra-large Dirt Bin, Aluminum Tube, Floor Brush, Suction Nozzle, Brush



## HGUN-007

### 20V Cordless Pressure Washer Kit with Brushless Motor

Rated Voltage	20V
Max Pressure	25Bar
Water Flow	210L/H
Motor Type	DC
Weight	1.35KG(bare)
Accessories	2x Li-ion Batteries, Charger, Nozzle, Hose, Long Lance, Soap Dispenser



## BT-S221

### 20V Cordless Recircation Saw with Brushless Motor

Rated Voltage	20V
Battery Capacity	2.0Ah
No Load Speed	3000rpm
Stroke Length	21mm
Chuck Type	SDS
Cutting Depth	Wood 200mm/ Steel 14mm
Weight	1.5KG(bare)
Accessories	2x Li-ion Batteries, Charger, Tool Bag



## BI-BTS125

### CORDLESS CIRCULAR SAW

Lithium-Ion Power Brushless

Voltage	20V
No-load Speed	7000rpm
Blade Dia.	125mm
Inner Dia.	20mm
90° Cutting	43mm
45° Cutting	31mm
Base Rotation	0-45°



## BT-CS185

### 185mm Circular Saw / 7"

Blade Dia.	185mm
Inner Dia.	20mm
No-load Speed	6000rpm
Input Power	1250W
Input Voltage	220V~240V
Rated Frequency	50/60Hz
90° Cutting	59mm
45° Cutting	38mm
Includes	Ruler, Brush, Wrench



## BT-CS235

### 235mm Circular Saw / 9"

Blade Dia.	235mm
Inner Dia.	25.4mm
No-load Speed	4000rpm
Input Power	2300W
Input Voltage	220V~240V
Rated Frequency	50/60Hz
90° Cutting	76mm
45° Cutting	54mm
Includes	Crosscut Guide, Brush, Wrench, Dust Collector, 210mm Saw Blade



## BT-MS210L

### 210mm Miter Saw with Laser / 8"

Blade Dia.	210mm
No-load Speed	5800rpm
Input Power	1200W
Input Voltage	220V~240V
Rated Frequency	50/60Hz
Max Cutting Capacity 0°	45x115mm (HxW)
Max Cutting Capacity 45°	45x95mm
Head Tilting 0°	45x115mm
Head Tilting 45°	25x115mm
Includes	Crosscut Guide, Brush, Wrench, Dust Collector, 210mm Saw Blade

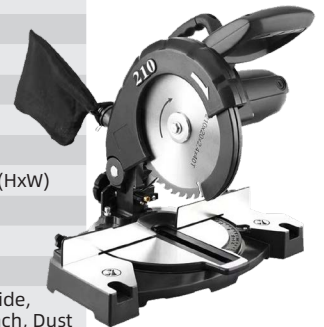

## BT-MS255

### 255mm Miter Saw / 10"

Blade Dia.	255mm
No-load Speed	4600rpm
Input Power	1650W
Input Voltage	220V~240V
Rated Frequency	50/60Hz
Max Cutting Capacity 0°	100x110mm (HxW)
Max Cutting Capacity 45°	100x85mm
Head Tilting 0°	90x110mm
Head Tilting 45°	40x86mm
Includes	Crosscut Guide, Brush, Wrench

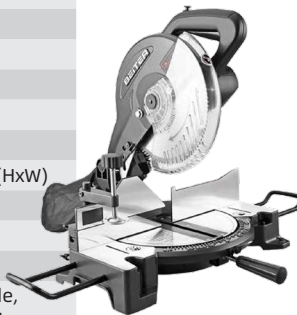

## BT-MS305

### 305mm Miter Saw / 12"

Blade Dia.	305mm
No-load Speed	5000rpm
Input Power	1800W
Input Voltage	220V~240V
Rated Frequency	50/60Hz
Max Cutting Capacity 0°	65x195mm (HxW)
Max Cutting Capacity 45°	45x195mm
Head Tilting 0°	65x140mm
Head Tilting 45°	45x135mm
Includes	Crosscut Guide, Brush, Wrench



## BT-MS355

### 355mm Miter Saw / 14"

Blade Dia.	355mm
No-load Speed	5000rpm
Input Power	2200W
Input Voltage	220V~240V
Rated Frequency	50/60Hz
Max Cutting Capacity 0°	65x210mm (HxW)
Max Cutting Capacity 45°	45x155mm
Head Tilting 0°	65x140mm
Head Tilting 45°	45x135mm
Includes	Crosscut Guide, Brush, Wrench



## BT-SMS255L

### 255mm Sliding Miter Saw with Laser / 10"

Blade Dia.	255mm
No-load Speed	6000rpm
Input Power	1800W
Input Voltage	220V~240V
Rated Frequency	50/60Hz
Max Cutting Capacity 0°	85x300mm (HxW)
Max Cutting Capacity 45°	85x210mm
Head Tilting 0°	45x200mm
Head Tilting 45°	45x210mm
Includes	Crosscut Guide, Brush, Wrench







## KEYLESS DRILL CHUCK

Model No.	Maximum Gripping Capacity	Internal Thread
BT-1038A	10mm	3/8"
BT-1338A	13mm	3/8"
BT-1312A	13mm	1/2"



## KEYLESS DRILL CHUCK(Aluminum Alloy)

Model No.	Maximum Gripping Capacity	Internal Thread
BT-13BLD	13mm	1/2"



## DRILL CHUCK

Model No.	Maximum Gripping Capacity	Internal Thread
BT-1038B	10mm	3/8"
BT-1312B	13mm	1/2"



## DRILL CHUCK for SCRE DRIVER

Model No.	Maximum Gripping Capacity	Internal Thread
BT-1038C	10mm	3/8"



## DRILL CHUCK ACCESSORIES

Model No.	Internal Thread
BI2100	3/8"
BI2101	1/2"
BI2102	1/2"



## M35 STEP DRILL

Model No.:	Body Length	Bit blade Length
BT-3422	78mm	53mm
BT-3430	102mm	77mm



## HSS M35 BLACK & GOLD TWIST DRILL BITS (Imperial Unit)

Model No.	Specification	Body Length	Bit Blade Length
BI5001	1/16"	1-7/8"	7/8"
BI5002	5/64"	2"	1"
BI5003	3/32"	2-1/4"	1-1/4"
BI5004	7/64"	2-5/8"	1-1/2"
BI5005	1/8"	2-3/4"	1-5/8"
BI5006	9/64"	2-7/8"	1-3/4"
BI5007	5/32"	3-1/8"	2"
BI5008	11/64"	3-1/4"	2-1/8"
BI5009	3/16"	3-1/2"	2-5/16"
BI5010	13/64"	3-5/8"	2-7/16"
BI5011	7/32"	3-3/4"	2-1/2"
BI5012	15/64"	3-7/8"	2-5/8"
BI5013	1/4"	4"	2-3/4"
BI5014	17/64"	4-1/8"	2-7/8"
BI5015	9/32"	4-1/4"	2-15/16"
BI5016	19/64"	4-3/8"	3-1/16"
BI5017	5/16"	4-1/2"	3-3/16"
BI5018	21/64"	4-5/8"	3-5/16"
BI5019	11/32"	4-3/4"	3-7/16"
BI5020	23/64"	4-7/8"	3-1/2"
BI5021	3/8"	5"	3-5/8"
BI5022	25/64"	5-1/8"	3-3/4"
BI5023	13/32"	5-1/4"	3-7/8"
BI5024	27/64"	5-3/8"	3-15/16"
BI5025	7/16"	5-1/2"	4-1/16"
BI5026	29/64"	5-5/8"	4-3/16"
BI5027	15/32"	5-3/4"	4-5/16"
BI5028	31/64"	5-7/8"	4-3/8"
BI5029	1/2"	6"	4-1/2"

## HSS M35 BLACK & GOLD TWIST DRILL BITS (Metric Unit)

Model No.	Specification	Body Length	Bit Blade Length
BI5030	0.3mm	19mm	3mm
BI5031	0.4mm	20mm	5mm
BI5032	0.5mm	22mm	6mm
BI5033	0.6mm	24mm	7mm
BI5034	0.7mm	28mm	9mm
BI5035	0.8mm	30mm	10mm
BI5036	0.9mm	32mm	11mm
BI5037	1mm	34mm	12mm
BI5038	1.1mm	36mm	14mm
BI5039	1.2mm	38mm	16mm
BI5040	1.3mm	40mm	18mm
BI5041	1.4mm	40mm	18mm
BI5042	1.5mm	43mm	20mm
BI5043	1.6mm	43mm	20mm
BI5044	1.7mm	46mm	22mm
BI5045	1.8mm	46mm	22mm
BI5046	1.9mm	49mm	24mm
BI5047	2mm	49mm	24mm
BI5048	2.1mm	49mm	24mm
BI5049	2.2mm	53mm	27mm
BI5050	2.3mm	53mm	27mm
BI5051	2.4mm	57mm	30mm
BI5052	2.5mm	57mm	30mm
BI5053	2.6mm	57mm	30mm
BI5054	2.7mm	61mm	33mm
BI5055	2.8mm	61mm	33mm
BI5056	2.9mm	61mm	33mm
BI5057	3mm	61mm	33mm
BI5058	3.1mm	65mm	36mm
BI5059	3.2mm	65mm	36mm
BI5060	3.3mm	65mm	36mm
BI5061	3.4mm	70mm	39mm



## HSS M35 BLACK & GOLD TWIST DRILL BITS (Metric unit)

Model No.	Specification	Body Length	Bit Blade Length
BI5062	3.5mm	70mm	39mm
BI5063	3.6mm	70mm	39mm
BI5064	3.7mm	70mm	39mm
BI5065	3.8mm	75mm	43mm
BI5066	3.9mm	75mm	43mm
BI5067	4mm	75mm	43mm
BI5068	4.1mm	75mm	43mm
BI5069	4.2mm	75mm	43mm
BI5070	4.3mm	80mm	47mm
BI5071	4.4mm	80mm	47mm
BI5072	4.5mm	80mm	47mm
BI5073	4.6mm	80mm	47mm
BI5074	4.7mm	80mm	47mm
BI5075	4.8mm	86mm	52mm
BI5076	4.9mm	86mm	52mm
BI5077	5mm	86mm	52mm
BI5078	5.1mm	86mm	52mm
BI5079	5.2mm	86mm	52mm
BI5080	5.3mm	86mm	52mm
BI5081	5.4mm	93mm	57mm
BI5082	5.5mm	93mm	57mm
BI5083	5.6mm	93mm	57mm
BI5084	5.7mm	93mm	57mm
BI5085	5.8mm	93mm	57mm
BI5086	5.9mm	93mm	57mm
BI5087	6mm	93mm	57mm
BI5088	6.5mm	101mm	63mm
BI5089	6.8mm	109mm	69mm
BI5090	7mm	109mm	69mm
BI5091	7.5mm	109mm	69mm
BI5092	8mm	117mm	75mm
BI5093	8.5mm	117mm	75mm
BI5094	9mm	125mm	81mm
BI5095	9.5mm	125mm	81mm
BI5096	10mm	133mm	87mm
BI5097	10.5mm	133mm	87mm
BI5098	11mm	142mm	94mm
BI5099	11.5mm	142mm	94mm
BI5100	12mm	151mm	101mm
BI5101	12.5mm	151mm	101mm
BI5102	13mm	151mm	101mm

## HSS M35 BLACK & GOLD TWIST DRILL BITS (Metric unit, Long size)

Model No.	Specification	Body Length	Bit Blade Length
BI5103	2mm	85mm	56mm
BI5104	2.5mm	95mm	62mm
BI5105	3mm	100mm	66mm
BI5106	3.5mm	110mm	73mm
BI5107	4mm	119mm	78mm
BI5146	4.2mm	119mm	78mm
BI5108	4.5mm	126mm	82mm
BI5109	5mm	132mm	87mm
BI5110	5.5mm	139mm	91mm
BI5111	6mm	139mm	91mm
BI5112	6.5mm	148mm	97mm
BI5113	7mm	156mm	102mm
BI5114	8mm	165mm	109mm
BI5115	9mm	175mm	115mm
BI5116	10mm	184mm	121mm



## HSS M35 BLACK & GOLD TWIST DRILL BITS (Metric unit, Long size)

Model No.	Specification	Body Length	Bit Blade Length
BI5117	13.5mm	151.8mm	75.9mm
BI5118	14mm	151.8mm	75.9mm
BI5119	14.5mm	151.8mm	75.9mm
BI5120	15mm	151.8mm	75.9mm
BI5121	15.5mm	151.8mm	75.9mm
BI5122	16mm	151.8mm	75.9mm
BI5123	16.5mm	151.8mm	75.9mm
BI5124	17mm	151.8mm	75.9mm
BI5125	17.5mm	151.8mm	75.9mm
BI5126	18mm	151.8mm	75.9mm
BI5127	18.5mm	151.8mm	75.9mm
BI5128	19mm	151.8mm	75.9mm
BI5129	19.5mm	151.8mm	75.9mm
BI5130	20mm	151.8mm	75.9mm
BI5131	21mm	151.8mm	75.9mm
BI5132	22mm	151.8mm	75.9mm
BI5133	23mm	151.8mm	75.9mm
BI5134	24mm	151.8mm	75.9mm
BI5135	25mm	151.8mm	75.9mm
BI5136	26mm	151.8mm	75.9mm
BI5137	27mm	151.8mm	75.9mm
BI5138	28mm	151.8mm	75.9mm
BI5139	29mm	151.8mm	75.9mm
BI5140	30mm	151.8mm	75.9mm
BI5141	32mm	151.8mm	75.9mm



## HSS M35 BLACK & GOLD TWIST DRILL BIT SET



**Model No.** BI5142

**Specification**  
1.5mm - 6.5mm

1, 2, 2.5, 3, 3.2, 3.5, 4, 4.5, 4.8, 5, 5.5, 6, 6.5mm

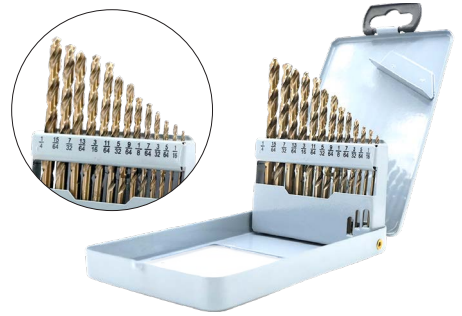

**Model No.** BI5147

**Specification**  
1/16" - 1/4"

1/16", 5/64", 3/32", 7/64", 1/8", 9/64", 5/32", 11/64", 3/16", 13/64", 7/32", 15/64", 1/4"

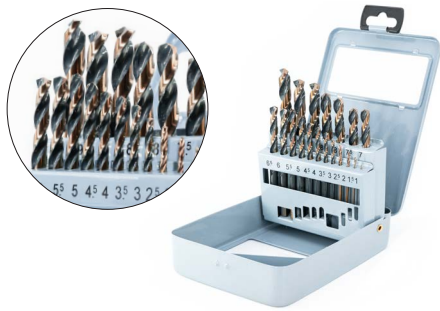

**Model No.** BI5145

**Specification**  
1mm - 10mm

1, 1.5, 2, 2.5, 3, 3.5, 4, 4.5, 5, 5.5, 6, 6.5, 7, 7.5, 8, 8.5, 9, 9.5, 10mm

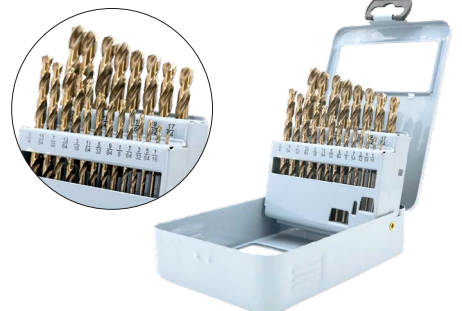

**Model No.** BI5148

**Specification**  
1/16" - 3/8"

1/16", 5/64", 3/32", 7/64", 1/8", 9/64", 5/32", 11/64", 3/16", 13/64", 7/32", 15/64", 1/4", 17/64", 9/32", 19/64", 5/16", 21/64", 11/32", 23/64", 3/8"

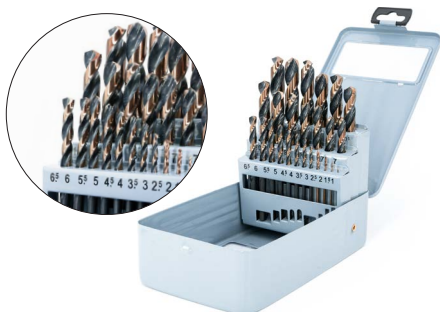

**Model No.** BI5143

**Specification**  
1mm - 13mm

1, 1.5, 2, 2.5, 3, 3.5, 4, 4.5, 5, 5.5, 6, 6.5, 7, 7.5, 8, 8.5, 9, 9.5, 10, 10.5, 11, 11.5, 12, 12.5, 13mm

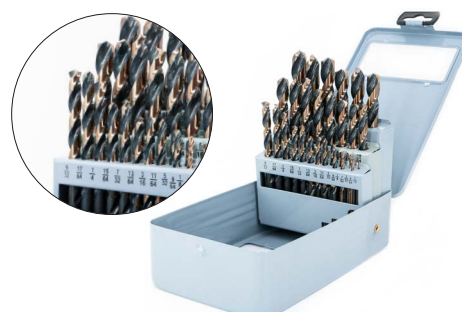

**Model No.** BI5144

**Specification**  
1/16" - 1/2"

1/16", 5/64", 3/32", 7/64", 1/8", 9/64", 5/32", 11/64", 3/16", 13/64", 7/32", 15/64", 1/4", 17/64", 9/32", 19/64", 5/16", 21/64", 11/32", 3/64", 3/8", 25/64", 13/32", 7/64", 7/16", 29/64", 15/32", 1/64", 1/2"

## Compatible with Below Platform's Battery



Beiter

Mujingfang

WORX

MAKITA

Devon



- Compatible with a Wide Range of Brand Platforms.
- Battery not Included.

### Beiter LED Work Light



### Magnetic Wall Bracket for LED Worklight

- Fix Worklight on a high location
- Enable 360 degrees rotation

### LWP-JB1

Model	P-LED-430	P-LED-548	P-LED-759	P-LED-884
Power	48W	48W	90W	90W
Voltage	20V	20V	20V	20V
Lumen	1500LM	2400LM	2950LM	4200LM
LED Chips	30	48	59	84
USB Port	Optional 5V 2A Output x 2 ports	Optional 5V 2A Output x 2 ports	Optional 5V 2A Output x 2 ports	Optional 5V 2A Output x 2 ports
Net Weight (without battery)	350g	460g	560g	525g



- Compatible with a Wide Range of Brand Platforms.
- Battery not Included.

### Handheld Flashlight

Model	P-LED-H4
Power	12W
Voltage	20V
Lumen	1120LM
LED QTY	4



- Compatible with a Wide Range of Brand Platforms.
- Battery not Included.

### 72W Li-ion Soldering Iron

Model	P-IS
Power Rating	72W
Heating Temperature	150°C - 480°C



## BT-00924

### LED Head Light

Power Supply	3*AAA
Working Time	7 hours
Adjustable Angle	45°
Light Color	White
Lumen	120LM



## BT-00940

### LED Li-ion Head Light

Power Supply	Lithium Battery 3.7V 1200mAH
Working Time	4 hours
Adjustable Angle	45°
Light Color	White and Red
Luminosity	120LM



## BT-L0D11S

### Multifunctional Mini Work Light

Material	ABS+PC+TPR+Nylon+Aluminum
LED Typ	30W COB
Luminous Flux	1000lm
Battery	2pcs 5V 5000mAh lithium Polymer Battery (5V 10000mAh in Total)
Product Size	92x45x102mm (L*W*H1*H2)
N.W.	360g (Battery Included)
Function	25%ON--2700K/3500K/4500K/6500K 50%ON--2700K/3500K/4500K/6500K 75%ON--2700K/3500K/4500K/6500K 100% ON-2700K/3500K/4500K/6500K Red LED ON/Red LED Strobe
Charging Time	6.0hrs
Running Time	100%- 1000lm- 5.5hrs 75%- 600lm- 9.5hrs 50%- 300lm- 21.0hrs 25%- 120lm- 36.5hrs
Waterproof	IPX4
Input & output	5V 2A (Power Bank Function)
Accessories	1pc 100cm Type-C USB Cable



## BT-HL700S

### Lithium-ion Led Headlamp

Material	Aluminum Alloy
LED Typ	1pc 8W SMD
Luminous Flux	700lm
Battery	2pcs 3.7V 2200mAh 18650 Li-ion Battery (Included)
Product Size	42*62mm(Dia.*H)
N.W.	285g (Battery Included)
Function	High/Low/Flash Zoom in/Out by Stretching The Head Part
Charging Time	4.5hrs
Running Time	High- 700lm- 4hrs Low- 100lm- 16.5hrs
Waterproof	IP44
Input & output	5V 1A Input and Output (Power Bank Function)
Accessories	1pc 50cm Type-C USB Cable



## BT-LC2000S

### Magnetic Foldable Led Work Light

Material	Nylon+Aluminum
LED Typ	20W-Sanan 60pcs 2835SMD
Luminous Flux	2000lm
Battery	4pcs 3.7V 2200mAh 18650 Li-ion Battery (Included)
Product Size	270x230x80x168mm (L*W*H1*H2)
N.W.	1060g (with Magnet)/1030g (without Magnet)
Mode	20W 100% ON/ 20W 50% ON/OFF
Charging Time	5.5hrs
Running Time	20W COB 50% ON 1000lm---(2.5hrs) 20W COB 100% ON 2000lm---(4.5hrs)
Waterproof	IP54
Input & output	5V 2A
Accessories	1pc 100cm Type-C USB Cable



## Beiter 2023 New Innovation - Patented Cordless Fans

- ✓ Outdoor Cordless
- ✓ Construction Sites Cordless
- ✓ Home Renovation Cordless



## Beiter 2023 New Innovation - Patented Cordless Fans

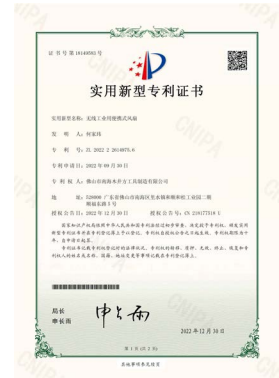

**Patented**

### 12" Features :

- ON/OFF Switch with 3-Speed Settings
- Low / 1200Rpm / 12W
- Middle / 1300Rpm / 14W
- Fast / 1400Rpm / 15W
- Raised by 90 degrees, Lowered by 3 degrees  
The air supply range is about 70 degrees
- Operating hours on a fully charged 4.0Ah battery is 5~7 hours \*
- AC powered rated voltage  
100V-240V ~ 50/60HZ

### 14" Features :

- ON/OFF Switch with 3-Speed Settings
- Low / 1150Rpm / 13W
- Middle / 1250Rpm / 20W
- Fast / 1350Rpm / 24W
- Raised by 90 degrees, Lowered by 3 degrees  
The air supply range is about 70 degrees
- Operating hours on a fully charged 4.0Ah battery is 5~7 hours \*
- AC powered rated voltage  
100V-240V ~ 50/60HZ

### Other Models



### Compatible with Various Platform's Battery:



Beiter Mujingfang WORX MAKITA Devon

\* The laboratory test data for reference only





### BT-BN900

Caulking Guns



### BT-8360

Pneumatic Glue Gun



### BT1013/BT1016/BT1019

Water Gun Nozzle

Size: 13mm/16mm/19mm



### BT-8109

Blind Riveting Pliers



### WS-521C

Beiter Master Torch

Size	140X40X66mm
Unit Weight	135g(excl.blister packing)
Callbre of Spout	φ22mm
Maximum Firepower	1300° C
Consumption of Gas	150g/h
Type of Gas	Butane
Appliance Category	Vapout Pressure-butane
Igniting Method	Automatic Piezoelectricity Ignite



### BT-300

Beiter Drag Saw

Body Length	400mm
Blade Length	300mm



### BCART-2R

Beiter Folding Cart( Two Retractable Wheels)

Carry Weight	80kgs
Net Weight	3kgs
Product Size	1000x380x420mm
Folded Size	640x380x55mm
Wheels Size/Material	5" PVC



### BCART-6R

Beiter Folding Cart ( Six Retractable Wheels)

Carry Weight	80kgs
Net Weight	4.2kgs
Product Size	1000x380x420mm
Folded Size	640x380x55mm
Wheels	6x4" TPR

## Pneumatic Nail Guns



### F32

#### 18GA BRAD NAILER

Weight	1.25KG
Height	125mm
Length	240mm
Width	60MM
Capacity	100PCS
Operating Pressure	60-100PSI



### 1010F

#### 22GA FINE WIRE STAPLER

Weight	0.94KG
Height	145mm
Length	207mm
Width	50MM
Capacity	140PCS
Operating Pressure	60-100PSI



### P630C

#### 23GA HEADLESS PINNER

Weight	0.92KG
Height	178mm
Length	215mm
Width	42MM
Capacity	150PCS
Operating Pressure	60-100PSI



### FST50B

#### 16GA 2" BRAD NAILER

Weight	2.8KG
Height	260mm
Length	313mm
Width	90MM
Capacity	50PCS
Operating Pressure	80-120PSI



### 422J

#### 20GA FINE WIRE STAPLER

Weight	1.17KG
Height	168mm
Length	240mm
Width	58MM
Capacity	100PCS
Operating Pressure	60-100PSI



### 8016B

#### 21GA FINE WIRE STAPLER

Weight	0.95KG
Height	145MM
Length	207MM
Width	50MM
Capacity	125PCS
Operating Pressure	70-100PSI
Air Inlet	1/4"NPT



### 8016BL

#### LONG NOZZLE 21GA FINE WIRE STAPLER

Weight	1.11KG
Height	210MM
Length	207MM
Width	50MM
Capacity	125PCS
Operating Pressure	70-100PSI
Air Inlet	1/4"NPT

## BEITER Professional Manual Tile Cutters



The MD-Series features a full-length one-piece die-cast aluminum base for absolute stability and precision. BEITER MD-Series tile cutters are ideal for the intensive cutting of ceramic tiles, especially for frequent cutting of ceramic tiles. Cutting length range from 400mm to 700mm, respectively equipped with single or double solid steel rails to achieve best performance for the money.

### MD-Series Versatile Professional Tile Cutters

Model #	Features	Cutting length	Unit Weight
MD440-2	Straight handle/ Double Rails	400mm (16in)	5.9KG
MD640-2	Curve ergonomic handle/ Double Rails	600mm (24in)	9.0KG



MD640-2

## MA-Series Industrial Grade Tile Cutters

The MA-Series is made for large-scale heavy-duty serious projects. BEITER MA-Series tile cutters feature robust design to handle premium tile cutting. Impressive cutting length ranges from 600mm up to 1600mm, with supporting arms. Diagonal cut makes easy. Laser guide are optional as an upgrade.

Model #	Features	Cutting length	Unit Weight	Diagonal Cut	Laser guide
MD680B-1(N)K*	Die-cast/Curve ergonomic handle/ Single "H" Solid Rail/ supporting arms *K=Peek Hole	600mm (24in)	9.0KG	✓	Optional
MA660-1(N)	Curve ergonomic handle/Single "H" Solid Rail/supporting arms	600mm (24in)	8.5KG	✓	Optional
MA860-1(N)	Curve ergonomic handle/Single "H" Solid Rail/supporting arms	800mm (32in)	11.7KG	✓	Optional
MA960-1(N)	Curve ergonomic handle/ Single "H" Solid Rail/supporting arms	900mm (36in)	12.8KG	✓	Optional
MA1060-1(N)	Curve ergonomic handle/ Single "H" Solid Rail/supporting arms	1000mm (40in)	13.6KG	✓	Optional
MA1260-1(N)	Curve ergonomic handle/ Single "H" Solid Rail/supporting arms	1200mm (48in)	15KG	✓	Optional
MA1660-1(N)	Curve ergonomic handle/ Single "H" Solid Rail/supporting arms x 2pairs	1600mm (63in)	19KG	✓	Optional



MD680B-1(N)K



MA860-1(N)



MA1660-1(N)

Special order:  
\*K= Peek Hole

L= Laser



## TH-Series Light-weight Everyday Tile Cutters

The new TH-Series features a slim aluminum body for modern household renovation use. BEITER TH-Series tile cutters are ideal for light projects in smaller areas. Its compact size is easy for storage and transportation. Cutting length range from 300mm to 600mm. A nice nylon bag can be added as upgrade

Model #	Features	Cutting length	Unit Weight	Nylon Bag
MA300-2TH	Straight handle/Double Rails	300mm (12in)	4.4KG	/
MA400-2TH	Straight handle/Double Rails	400mm (16in)	5KG	/
MA500-2TH	Straight handle/Double Rails	510mm (20in)	6KG	/
MA600-1TH(N)	Straight handle/Single "H" Solid Rail/ Supporting arms	600mm (24in)	7KG	Optional
MA600-2TH(N)	Straight handle/Double Rails/ Supporting arms	600mm (24in)	8KG	Optional
XMA600-2(N)	Die-cast base/Super slim body/ Super light-weight/Supporting arms	600mm (24in)	6KG	Optional



MA300-2TH



MA600-1TH



XMA600-2(N)

Nylon Bag



## Cutting Wheel

### MD.A-215

Replaceable tungsten-alloy cutting wheel from Japan





## MARINE & AUTO ENGINEERING

### Elevate Your Efficiency with BEITER Tools Solutions - Maximize Time and Savings

In the dynamic world of automotive and marine maintenance, the quest for efficiency, safety, and organization is never-ending. BEITER has been at the forefront of this journey since 2019, revolutionizing over 100 auto shops, barges, and shipyards with our innovative tools solutions and toolsets. Our mission is simple: to ensure a seamless, organized, and secure working environment for all.

### A Spectrum of Solutions for Every Need

Whether you're servicing cars, motorbikes, tankers, yachts, ferries, leisure boats, water toys, work boats, tugs, or jack-up rigs, BEITER has a tailored solution that fits. Our heavy-duty cases and cabinets are designed for the ultimate storage and transport efficiency, ensuring every tool is exactly where you need it, when you need it.

### Designed for Convenience and Security

With BEITER, every tool has its designated spot, making it effortless to locate, use, and return. This not only saves precious time but also enhances workplace safety and productivity. The clear organization means you can instantly notice if a tool is missing, reducing the risk of delays or accidents.

### Your Partner in Precision and Performance

Choose BEITER tools solutions for a workplace that embodies tidiness, efficiency, and security. Our commitment to quality and customer satisfaction ensures that your operations run smoothly, allowing you to save time and money without compromising on performance.

Embrace the BEITER difference today and transform your workspace into a model of efficiency and safety.



### High Quality Brand Lock

#### Hardware accessories

Lock plate thickening treatment, more effective protection. Thicker key, not easy to break, rust



### Bulkhead and Hook

#### Diaphragm and hook

With the use of baffle and hook, the height of plate layer can be adjusted at will, the load bearing can be increased, the plate is not easy to deform, convenient and flexible. Hooks can be used separately according to different tools. (Contact customer service for detailed hook requirements)



## Marine Specialized Tools



### 21GA FINE WIRE STAPLER

#### 8016B

Weight	0.95KG
Height	145MM
Length	207MM
Width	50MM
Capacity	125PCS
Operating Pressure	70-100PSI
Air Inlet	1/4"NPT

### LONG NOZZLE 21GA FINE WIRE STAPLER

#### 8016BL

Weight	1.11KG
Height	210MM
Length	207MM
Width	50MM
Capacity	125PCS
Operating Pressure	70-100PSI
Air Inlet	1/4"NPT

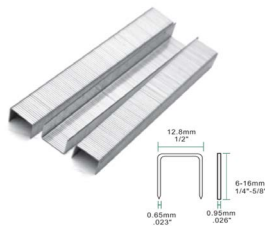

### STAPLE SPECIFICATIONS

MODEL	SIZE	FINISH	BOX/QTY	BOX/CTN
8006	1/4"(6mm)	Galvanized	10000	20
8008	5/15"(8mm)	Galvanized	10000	20
8010	3/8"(10mm)	Galvanized	10000	10
8012	1/2"(12mm)	Galvanized	10000	10
8014	9/16"(14mm)	Galvanized	10000	10
8016	5/8"(16mm)	Galvanized	10000	10

## Light-weight Brushless Power Tools



### BT430-16V

### BT432-16V



### Accessories



### C16-4B1 16V Brushless POWER COMBO KIT

Item No.	BT430-16V BL	BT432-16V BL
Rated Voltage	16V	16V
Battery Capacity	2.0Ah	2.0Ah
No Load Speed	0-500/1500rpm	0-500/1500rpm
Chuck Size	10mm	10mm
Impact Rate	/	0-1100/3200bpm
Max Torque	40Nm	40Nm
Torque Setting	20+1	20+1+1
Drilling Capacity	Wood 20mm/Steel 10mm	Wood 20mm/Steel 10mm/Concrete 8mm
Accessories	2x Li-ion Batteries, Charger, Tool Box	

## PORTABLE CASES

MARINE USE - IP67 Waterproof

Other Areas of Use:  
Drones, Measuring Devices, Medical Devices, Cameras,  
Equipment, Security, Electronics, Etc.



## MG9-Series

Color: Black/ Customized  
Material: PP/ ABS



Item No.	Size(LxWxH) Outer(mm)	Inner(mm)	Lid Height/ Body Height
MG9194	216*165*95	194*128*80	19/67mm
MG9195	236*180*95	215*144*87	27/60mm
MG9255	285*230*100	255*183*86	26/60mm
MG9256A	287*220*152	256*182*143	28/115mm
MG9256B	287*220*107	256*182*98	28/70mm
MG9262A	290*243*130	262*202*120	30/90mm
MG9262B	290*243*110	262*202*100	30/70mm
MG9297	327*216*155	297*178*146	27/119mm
MG9300A	346*250*136	300*200*126	30/96mm
MG9300B	346*250*110	300*200*95	30/65mm
MG9326A	363*290*160	326*246*150	31/119mm
MG9326B	363*290*136	326*246*126	31/195mm
MG9326C	363*290*114	326*246*104	31/73mm
MG9395A	430*350*190	395*295*179	41/138mm
MG9395B	430*350*150	395*295*136	41/95mm
MG9405	446*345*155	405*298*143	41/102mm
MG9595	653*450*235	595*430*217	45/172mm

## LAND USE Heavy-duty CASES - Non-waterproof



Item No.	Size(LxWxH) Outer(mm)	Inner(mm)	Lid Height/ Body Height	Material
BC4133S	460*370*146	410*325*127	2250g	PP
BC4133M	460*370*206	410*325*187	2500g	PP
BC4133L	460*370*276	410*325*257	3250g	PP







# Merchandising

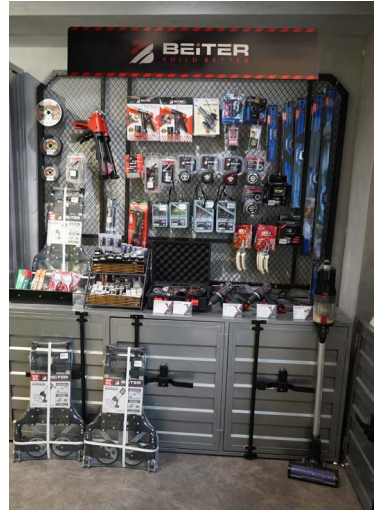
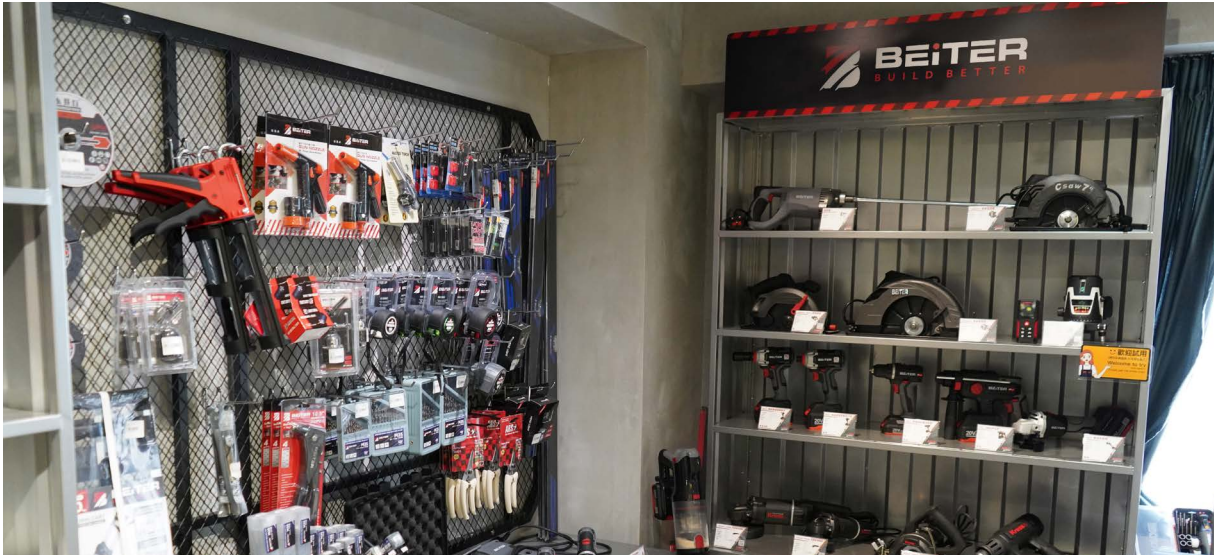

# Merchandising

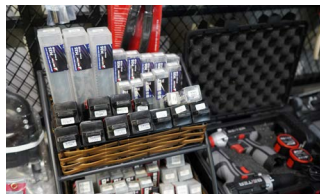
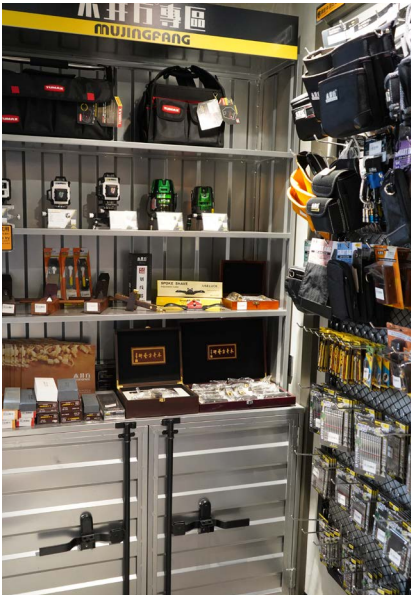



**BEITER**  
B U I L D B E T T E R

## **AUTHORIZED DISTRIBUTOR**



**BEITER TECHNOLOGIES USA LLC**  
**BEITER INTERNATIONAL LIMITED**

**Wah Tat Hardware & Tools Limited**

11-13/F, Fuk Keung Industrial Building, 66-68 Tong Mei Rd, Kowloon, Hong Kong

**Woodwell Tools Manufacturing Limited**

5 Shunfu Road East, Heshun Hegui Industrial Estate B, Lishui Town,  
Nanhai District, Foshan City, Guangdong 528241, China

**Beiter Technologies USA LLC**

2309 Noriega St, San Francisco, CA94122

[www.beitertools.com](http://www.beitertools.com)

Tel: +86(757)85113370

Email: [info@beitertools.com](mailto:info@beitertools.com)

Hong Kong China United States